

Thank you for choosing

Panasonic OmniVision **VHS**

MODEL PV-4609/PV-4659

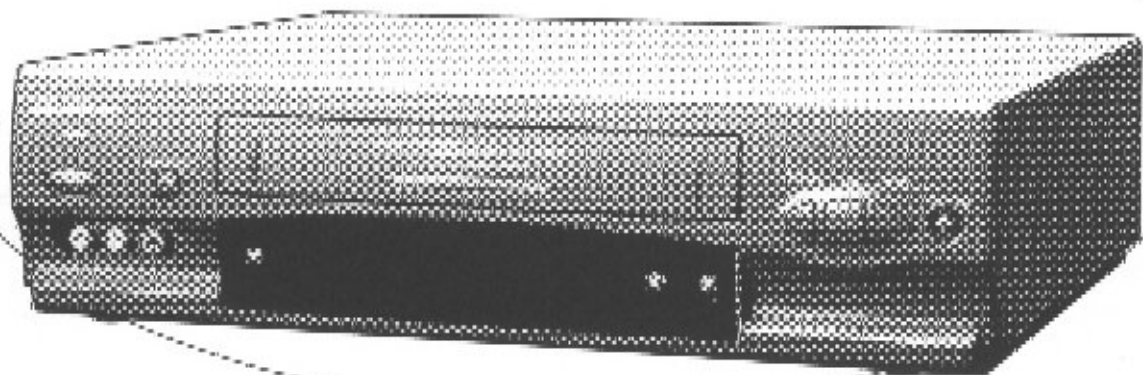

Video Cassette Recorder

Operating Instructions

Please read these instructions carefully before attempting to connect, operate or adjust this product and save this manual.
Spanish Quick Use Guide is included.
Guía para rápida consulta en español está incluido.

P6 ~ P9
Connections

P10 ~ P12
Getting Started

P13 ~ P16
Basic Operation

P17 ~ P23
More You Can Do

P24 ~ Back Cover
Other Information

Things You Should Know

Congratulations

on your purchase of one of the most sophisticated and reliable products on the market today. Used properly, we're sure it will bring you and your family years of enjoyment. Please take time to fill in the information at right. The serial number is on the tag located on the back of your VCR. You'll want to keep this manual handy as your convenient VCR information source.

Date of Purchase _____
Dealer Purchased From _____
Dealer Address _____
Dealer Phone No. _____
Model No. _____
Serial No. _____

Safety Precautions

Warning: To prevent fire or shock hazard, do not expose this equipment to rain or moisture. This video recorder, equipped with the HQ (High Quality) System, is compatible with existing VHS equipment.

Only use those tapes with the **VHS** mark. It is recommended that only cassette tapes that have been tested and inspected for use in 2, 4, 6, and 8 hour VCR machines be used.

FCC Warning: Any unauthorized changes or modifications to this equipment would void the user's authority to operate.

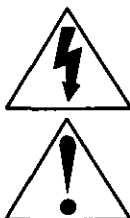

This symbol warns the user that uninsulated voltage within the unit may have sufficient magnitude to cause electric shock. Therefore, it is dangerous to make any kind of contact with any inside part of this unit.

This symbol alerts the user that important literature concerning the operation and maintenance of this unit has been included. Therefore, it should be read carefully in order to avoid any problems.

Table of Contents

| | |
|---|---|
| Important Safeguards and Precautions | 3 |
| Unpacking Your VCR and Features | 4 |
| VCR and Cassette Information (Record Tab, Tape Speeds, Tape Cleaning, Specifications) | 5 |

Connections

| | |
|--|------|
| Basic Connection (Antenna and VCR, VCR and TV) | 6, 7 |
| Additional Connections (CATV, Audio/Video) | 8, 9 |

Getting Started

| | |
|--|--------|
| One Time VCR Setup (On-screen Language, Channel Memory, Clock Set) | 10, 11 |
| On Screen Displays (OSD) (Function, Channel, Menu, VCR Status & Clock, Warning, Instruction) | 12 |

Basic Operation

| | |
|---|--------|
| Playback a Tape (Main Operation, Special Effects, Quality Picture Features) | 13 |
| Record On a Tape (Main Operation, One Touch Record, Channel Selection, Select Input Mode) | 14, 15 |
| Tape Operation (Repeat Play, One Minute Skip, Zero Search, Auto Functions) | 16 |

More You Can Do

| | |
|--|--------|
| Copying Your Tapes (Dubbing) (Connection, Main Operation, Monitoring) | 17 |
| Timer Recording (Main Operation, Cancel-Clear or Replace, Program Contents) | 18, 19 |
| Timer Recording Using VCR Buttons | 20 |
| Special VCR Features (VCR Lock, Warning Beeper) | 21 |
| MTS Broadcast/ VHS Hi-Fi Stereo System (Stereo/SAP/Mono Broadcast, Select Audio Mode) | 22, 23 |
| (For Model PV-4659 only) | |

Other Information

| | |
|---|----------------|
| Before Requesting Service (Self-check items) | 24 |
| Spanish Quick Use Guide/Guía para rápida consulta | 25, 26 |
| Index of Controls (Remote Control, VCR) | 27, Back Cover |

Important Safeguards and Precautions

INTRODUCTION

Careful attention has been given to this Video product to assure a quality standard devoted to your safety and enjoyment. This quality standard together with your personal responsibility for the safety of yourself and others, will contribute to your enjoyment. This Video product uses electrical energy and requires proper handling at all times.

CAUTION

READ AND RETAIN THE SAFETY AND OPERATING INSTRUCTIONS
To make full use of the safeguards incorporated in this unit, read and follow this basic guide, adopted in part from Underwriter's Laboratories Standard 1409, Second Edition, before operating this Video product.

FOLLOW THE INSTRUCTIONS AND BE SURE TO HEED ALL WARNINGS on unit and in the manual, for easy maintenance, proper and trouble free operation of this Video product.

INSTALLATION

- OPERATE FROM A POWER SOURCE INDICATED** on this Video product, or in this Manual. Your Electric Utility Service Company or Video Products Dealer will be happy to verify the power source in your home.
- THE GROUNDED OR POLARIZED PLUG IS A SAFETY FEATURE** This Video product may be equipped with either a polarized 2-wire AC line plug or a 3-wire grounding type plug. The two wire polarized plug (having one blade wider than the other) will fit into the power outlet only one way. If it is a three wire grounding type plug (having a third pin), it will fit into a grounding type outlet.
- DO NOT DEFEAT THE SAFETY PURPOSE OF THE GROUNDED OR POLARIZED PLUG** by tampering with it. If the plug does not fit fully into the socket, try reversing it. If you should still be unable to fully insert the plug into the socket, you may find that a proper outlet is needed to meet today's Electrical Standards. An electrician will replace your outlet safely.
- POWER SUPPLY CORDS SHOULD BE PROTECTED** and routed so that they are not likely to have anything rest on them, roll over them, or be subject to walking traffic or abuse: particularly at plug-ins, convenience receptacles, or cord exit points from the unit. Where an extension is needed, use a grounded or polarized cord.
- HAZARDOUS FRAYED CORDS OR DAMAGED PLUGS SHOULD BE REPLACED BY A QUALIFIED SERVICE TECHNICIAN.**
- OVERLOADED WALL OUTLETS AND EXTENSION CORDS PRESENT DANGEROUS RISKS OF FIRE OR ELECTRICAL SHOCK.**
- AVOID BLOCKING VENTILATION HOLES**
Your video unit has ventilation openings in its cabinet to release heat generated during operation. Blocking these opening can cause heat build-up inside the unit, causing failure that may result in a fire hazard or heat damage to cassettes. For protection:
 - Never cover the bottom ventilation slots or the unit with soft material, or operate the unit placed on a bed, sofa, rug, or soft accessory.
 - Avoid built-in installations, such as a bookcase or rack, unless proper ventilation is provided.
- AVOID EXTREMELY HOT LOCATIONS OR SUDDEN CHANGES IN TEMPERATURE** such as placing the unit near or over a radiator, in direct sunlight, closed vehicles, or transporting it suddenly between areas of extreme temperature variation.
If the unit is suddenly moved from a cold place to a warm place, moisture may form on the tape and inside the unit.
- TO AVOID INJURY TO A CHILD, ADULT; OR COSTLY DAMAGE:**
 - Do not place unsecured equipment on a sloping surface or any heavy object or unit.
(Use the unit in a horizontal position and do not place anything heavy on it.)
 - Support for the unit should be adequately firm, level, and strong. Replace any unstable cart, table or support. An appliance and cart combination should be moved with care. Quick stops, excessive force, and uneven surfaces may cause the appliance and cart combination to overturn.
 - Carefully follow all operating instructions and use the manufacturer's recommended accessories when operating this unit or connecting it to any other equipment.



OUTSIDE ANTENNA, EQUIPMENT, AND POWERLINE EXPOSURE

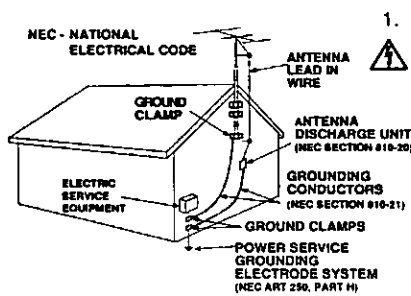

- INSURE SAFE ANTENNA AND CABLE CONNECTIONS**
If an outside antenna or cable system is connected to the equipment, be sure the antenna or cable system is grounded so as to provide some protection against built up static charges and voltage surges. Part 1 of the Canadian Electrical Code, in USA Section 810 of the National Electrical Code, ANSI/NFPA

70, provides information with respect to proper grounding of the mast and supporting structure, grounding of the lead-in wire to an antenna discharge unit, size of grounding conductors, location of antenna discharge unit, connection to grounding electrodes and requirements for the grounding electrode.

- ELIMINATE ANTENNA PROXIMITY TO HIGH VOLTAGE POWER SOURCES, OR CHANCE OF ACCIDENTAL CONTACT BY INSTALLER**
An outside antenna system should be located where it will never be reached by power lines, electric light or power circuits and where it will never contact these power sources if it falls. Installer should use extreme care to avoid possible fatal contact by touching power lines, circuits or other power sources when installing an outside antenna.

USE

AFTER STORING OR WHEN MOVING THE UNIT, REFER TO THE INSTALLATION SECTION OF THE SAFEGUARDS.

- DO NOT USE THIS VIDEO UNIT NEAR WATER:** around bathtubs, sinks, laundry, wet basement, swimming pool or any water source.
- USE ACCESSORIES RECOMMENDED ONLY BY THE MANUFACTURER** to avoid risk of fire, shock or other hazards.
- UNPLUG ALL EQUIPMENT EXPOSED TO RAIN, MOISTURE, OR STRONG IMPACT AND GET A QUALIFIED INSPECTION**
If your unit has been exposed to rain, water, excessive moisture, or subjected to strong impact, unplug it and have it inspected by a service technician before use.
- UNPLUG UNUSED UNIT, AND ALL EQUIPMENT DURING A STORM**
During a lightning storm, when indoors or outdoors, or before leaving unit unused for extended periods of time, disconnect all equipment from power source, antenna and cable system.
- UNPLUG ALL EQUIPMENT BEFORE CLEANING.** After unit has been unplugged use a dry, clean, chemically untreated cloth. Use no cleaning fluids, aerosols, or forced air that could over-spray, or soak into the unit, and cause electrical shock. Any substance such as wax, adhesive tape, etc. may affect the cabinet surface.
Exposure to greasy, humid, or dusty areas may affect internal parts.
- WHEN PLUGGED-IN: KEEP WATER AWAY; NO FINGERS INSIDE NOR ANY OBJECTS INSIDE; AND NO MAGNETS OR ELECTRICAL INTERFERENCE NEARBY.**
 - Never operate the unit if liquid has been spilled into it. Immediately unplug the unit, and have it inspected by a service technician. Fire and shock hazards can result from electrical shorts caused by liquid contact inside.
 - Caution the children about dropping or pushing objects into the unit. Some parts inside carry hazardous voltages and contact can cause electric shock. Objects dropped in electrical equipment can cause fire hazards.
 - Separate the unit from any interference causing appliances. Placing the unit directly above or below your TV set may cause electrical interference. Keep all magnets away from electronic equipment.

SERVICE

- DO NOT ATTEMPT TO SERVICE THIS PRODUCT YOURSELF.** If this Video product does not operate as described, when the detailed Operating Instructions are followed, do not attempt to open or remove covers, or make any adjustments not described in the manual. Attempting to service this unit yourself may expose you to dangerous voltage or other hazards. Refer all servicing to qualified service personnel.
- CHECK ON REPLACEMENT PARTS REQUIRED.** Be sure the service technician has used replacement parts specified by the manufacturer or having the same characteristics as the original part. Unauthorized substitutes may result in fire, electric shock or other hazards.
- HAVE TECHNICIAN PERFORM SAFETY CHECK** described in the manufacture's service literature, after any service or repairs, to determine that the Video unit is in safe operating order.

Unpacking Your VCR and Features

Unpacking Your VCR

The accessories shown below are provided to help you use or set up your VCR.
Optional accessories are also listed.

Accessories

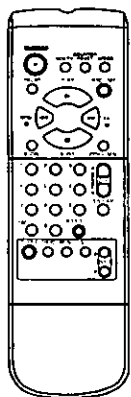

Remote Control
VSQS1402

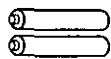

2 "AA"
Batteries



RF Coaxial
Cable
VJAS0183

Optional Accessories

- 1/2" Video Cassette Tape

Load the batteries in the Remote Control

1 Lift off the lid after pressing in and up on the latch with your thumb nail or other narrow object.

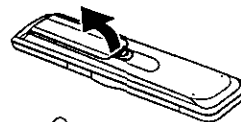

2 Install two batteries as indicated inside the Battery Compartment.

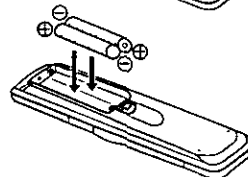

3 Fit the lid's hinge piece into the indent on the case, and snap lid into place.

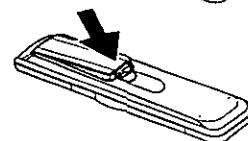

Battery replacement caution

- Do not mix old and new batteries. (Also, never mix alkaline with manganese batteries.)

Product Features

| | |
|---|----------------|
| All Channel Auto Set/ 181-CH TV/CATV Tuner | 10 |
| Auto Daylight Saving Time | 5 |
| Auto Operation Functions (Auto Playback, Rewind, Tape Eject, Power off) | 16 |
| Auto Repeat Function | 16 |
| Digital Auto Picture | 13 |
| Easy-to-Read English/Spanish/French On Screen Displays | 10, 11, 18, 19 |
| Front-mounted A/V In Terminals | 17 |
| MTS Broadcast System (For Model PV-4659 only)(Multi-channel Television Sound-Stereo, SAP, Mono) | 22 |
| One Minute Skip | 16 |
| One Month, 8 Program Timer Recording | 18, 19 |
| One Touch Recording (OTR) | 14 |
| Quick Play Mechanism | 24 |
| Special Effects Playback | 13 |
| Special VCR Features (VCR Lock, Warning Beeper) | 21 |
| VHS Hi-Fi Stereo System (For Model PV-4659 only) | 23 |
| Zero Search | 16 |

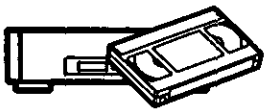

VCR and Cassette Information

Erase Protection (Record Tab)

Cassettes have a record tab to ensure that recordings are not accidentally erased.

To prevent accidental erasure, break off the tab with a screwdriver.



To record again, cover the hole with cellophane tape.



Maximum Record/Playback Time

Only use tapes with the **VHS** mark in this unit.

| Tape Speed Position | Type of Video Cassette | | |
|-----------------------|------------------------|---------|--------------------|
| | T60 | T120 | T160 |
| SP (Standard Play) | 1 Hour | 2 Hours | 2 Hours 40 Minutes |
| LP (Long Play) | 2 Hours | 4 Hours | 5 Hours 20 Minutes |
| SLP (Super Long Play) | 3 Hours | 6 Hours | 8 Hours |

Cleaning Care for Video Heads

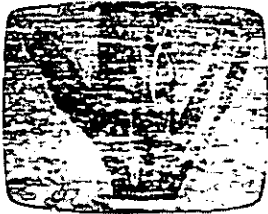

Clogged Video Head Picture

or

Blue Back
(During playback of pre-recorded tape)

Blue Back Screen

Clogged Video Heads

While your VCR will not normally require head cleaning, however the heads may become clogged when playing an old or damaged tape. If the image on your screen resembles the illustration on the left or the screen becomes solid blue when playing back a pre-recorded signal on the tape, the heads probably require cleaning.

Cleaning the Heads

It is recommended that head cleaning be performed by a qualified service technician. Please contact your nearest Panasonic Service Center. An alternate solution is to obtain a head cleaning cassette. Be sure to follow the cleaning instructions carefully. Excessive use of a cleaning cassette could shorten head life. Use this cassette only when symptoms occur.

Reset all VCR Memory Functions

This operation is convenient when moving the VCR to a new location, or if a mistake was made in the One Time VCR Setup section. Make sure a tape is not inserted in the VCR.

- 1) Turn VCR Power on.
- 2) Press and hold both Play and Rewind buttons on the VCR for more than 5 seconds.
 - The power will shut off.
- 3) Perform the One Time VCR Setup section on page 10.

D.S.T. (Daylight Saving Time)

Spring:

First Sunday in April (DAYLIGHT SAVING TIME: AUTO)
Automatically adds one hour and adjusts the clock.

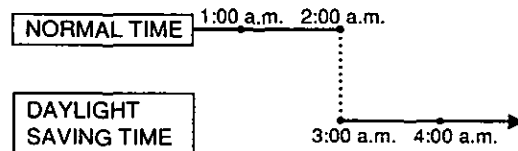

Autumn:

Last Sunday in October (DAYLIGHT SAVING TIME: AUTO)
Automatically turns back one hour and adjusts the clock.

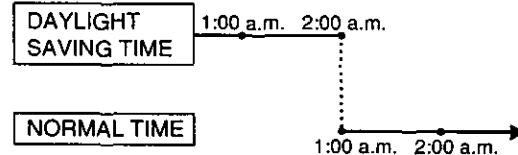

Product Specifications

- Power Source:** 120V AC, 60 Hz
- Power Consumption:** Approx. 18 watts (Power On) (PV-4609)
Approx. 23 watts (Power On) (PV-4659)
Approx. 6 watts (Power Off) (PV-4609)
Approx. 7 watts (Power Off) (PV-4659)
- Video Signal:** EIA Standard NTSC color
- Video Recording System:** 4 rotary heads helical scanning system
- Audio Track:** 1 track (Normal)
2channel (Hi-Fi Audio Sound) (PV-4659)
- Tuner:**
- Broadcast Channels:** VHF 2~13, UHF 14~69
- CATV Channels:** Midband A through I (14~22)
Superband J through W (23~36)
Hyperband AA~EEE (37~64)
Lowband A-5~A-1 (95~99)
Special CATV channel 5A (01)
Ultraband 65~94, 100~125
- Operating Temperature:** 41°F~104°F (5°C~40°C)
- Operating Humidity:** 10%~75%
- Weight:** 7.9 lbs. (3.6 Kg) (PV-4609)
8.2 lbs. (3.7 Kg) (PV-4659)
- Dimensions:** 14-3/16" (W) X 3-1/2" (H) X 11-1/4" (D)
360 (W) X 89 (H) X 285 (D) mm

Note: Designs and specifications are subject to change without notice.



Basic Connection

ANTENNA

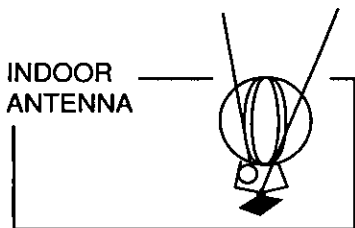

INDOOR ANTENNA

or

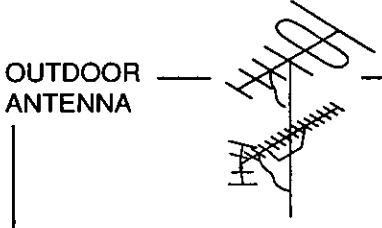

OUTDOOR ANTENNA

or

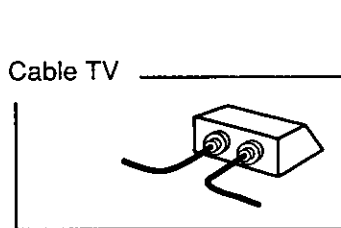

Cable TV

Disconnect the antenna or cable from your TV and connect it to the VCR (IN FROM ANT.)

VCR

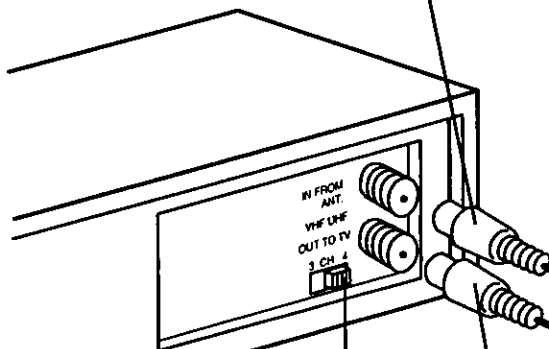

Set the Output Channel of your VCR to channel 3 or 4 (whichever is not being transmitted on by a Local TV broadcast).

Antenna Cable

TV

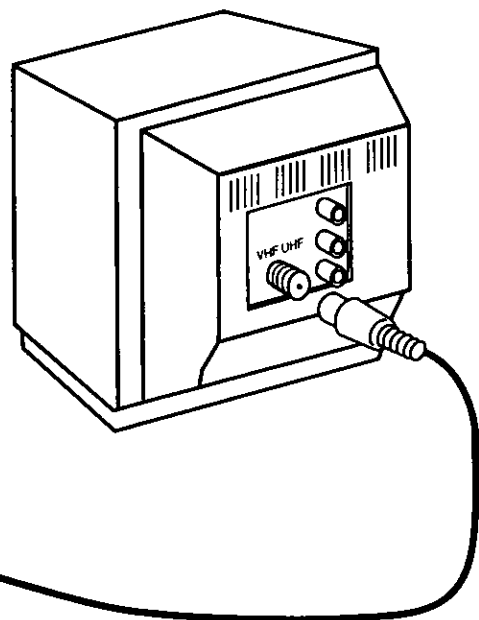

RF Coaxial Cable (VCR-TV Connection Cable) (supplied)

Connect the VCR to your TV with the RF Coaxial Cable (OUT TO TV).

Between Antenna and VCR

Case 1: Twin Lead Cable Only

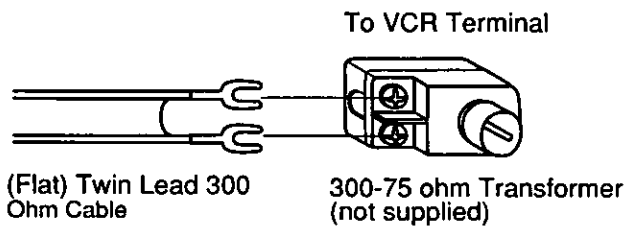

Case 2: Twin Lead & Coaxial Cables

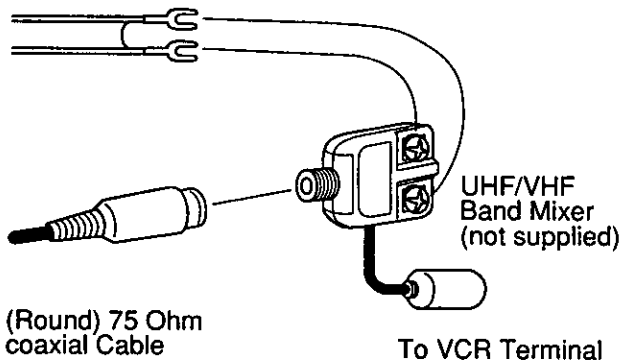

Case 3: Two Twin Lead Cables

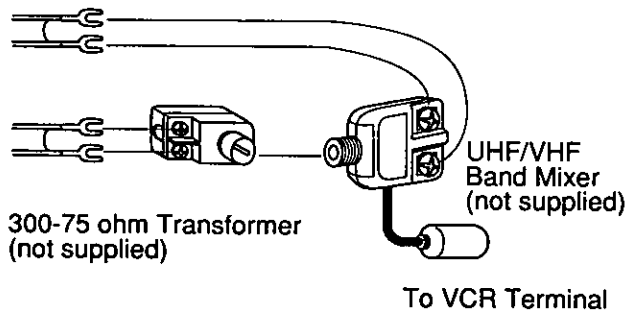

- If your TV has both post and screw-type VHF terminals, using the post connection is recommended to minimize signal loss.

Between VCR and TV

Case 1: Screw & Plug Type Terminal

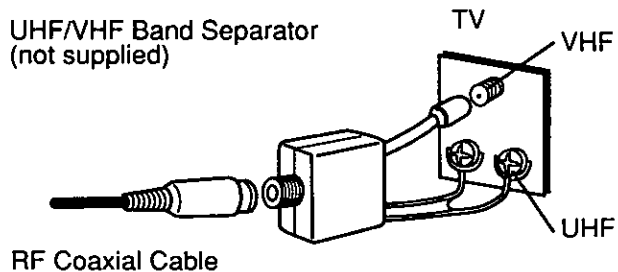

Case 2: Screw Type Terminal

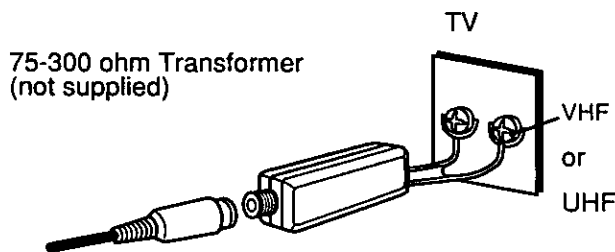

Case 3: Double Screw Type Terminal

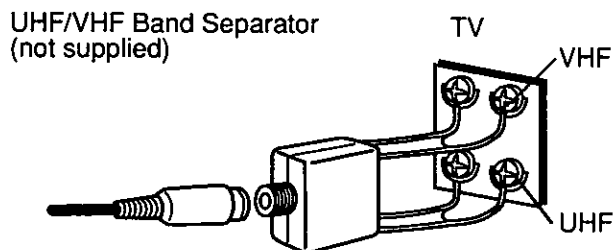

Case 4: Complex TV Terminal

TERMINALS ON BACK OF TV SET

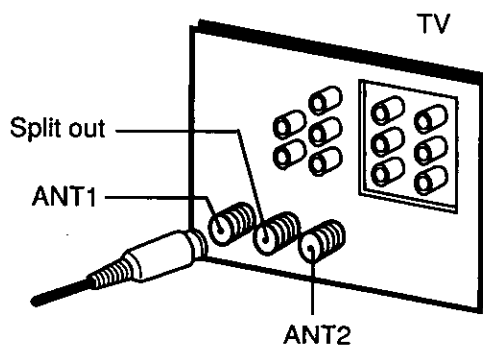

- Connect to one of the ANT terminals and select the same antenna number on the TV.



Additional Connections

CATV(Cable) Connections

All connections on this page are made with 75 Ohm coaxial cables.

Without a Converter/Descrambler Box

You can:

- 1) Use your VCR Remote Control to select channels.
- 2) Program one or more unscrambled channels for unattended recording.

NOTE: You cannot record or view scrambled channels with this connection.

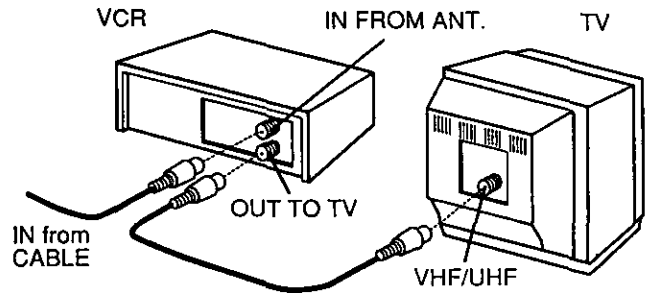

With a (CABLE to VCR) Converter/Descrambler Box

You can:

- 1) Record and view any channel including scrambled channels; channel selection must be made at the Cable TV Converter Box.
- 2) Program one channel for unattended recording.

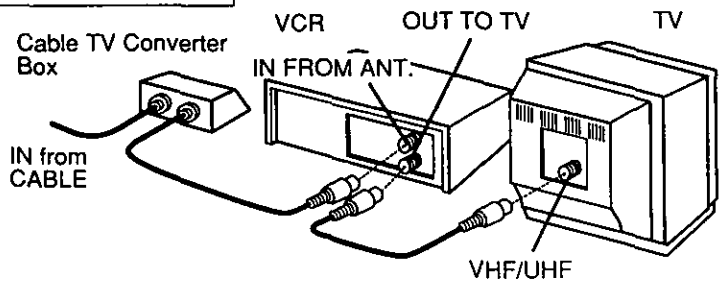

With a (VCR to TV) Converter/Descrambler Box

You can:

- 1) Use your VCR Remote Control to select channels.
- 2) Program unattended recordings of more than one unscrambled channel.

NOTE: You cannot record scrambled channels with this connection.

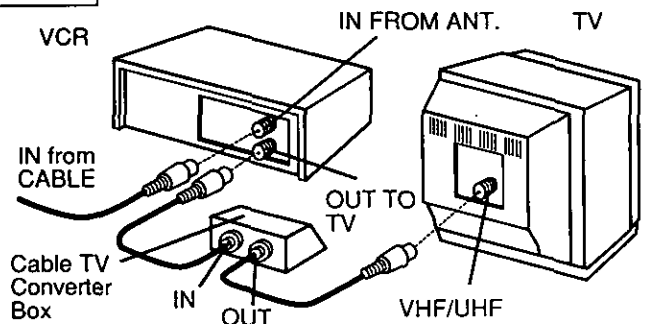

With Two Converter/Descrambler Boxes

If you want to record and view a combination of scrambled and unscrambled channels, you will need additional equipment. This connection requires two converter boxes, an A/B switch, and a 2-way splitter as shown here.

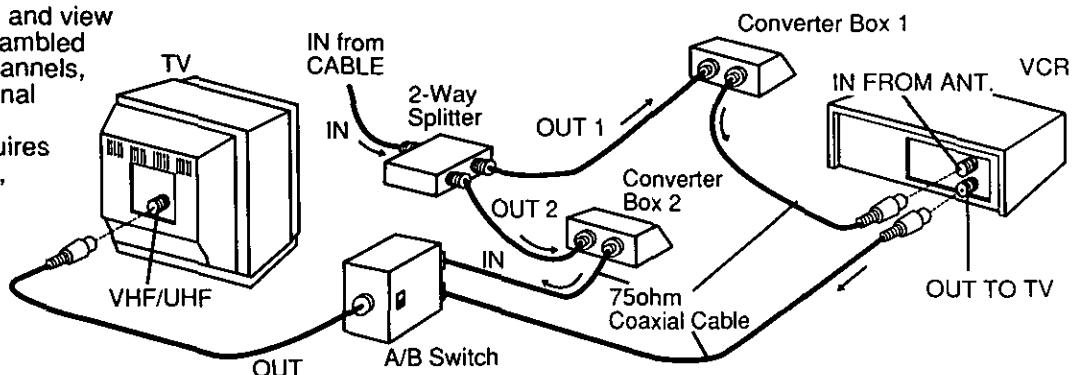

Audio/Video Connections

If your TV has AUDIO IN and VIDEO IN terminals, you can connect your VCR to them to receive a higher quality picture and sound. The antenna-VCR and VCR-TV connection is as shown.

Audio/Video Connections

1 Connect the VIDEO OUT terminal on the VCR to the VIDEO IN terminal of your TV.

2 Connect the "L" and "R" AUDIO OUT terminals on the VCR to the "L" and "R" AUDIO IN terminals of your TV.

3 Set the VIDEO/TV selector of your TV (Monitor/Receiver) to "VIDEO."

NOTE: To use your TV as a VCR monitor, set the VIDEO/TV selector on the TV (Monitor/Receiver) to "VIDEO."

Stereo Amplifier Connections

When you connect your VCR to a Stereo Component System, you can view the picture from the VCR while enjoying stereo from your audio system.

Connect the "L" and "R" AUDIO OUT terminals on the VCR to the "L" and "R" AUDIO IN terminals of your stereo.

Note to CATV system installer:

This reminder is provided to call the CATV system installer's attention to Article 820-40 of the NEC in USA (and to the Canadian Electrical code in Canada) that provides guidelines for proper grounding and, in particular, specifies that the cable ground shall be connected to the grounding system of the building, as close to the point of cable entry as practical.



One Time VCR Setup

When the VCR power is first turned on, the language select and channel auto set screen appear automatically followed by a prompt to set the clock.



Check list before you begin.

- All TV and VCR connections are made. (See pages 6~9.)

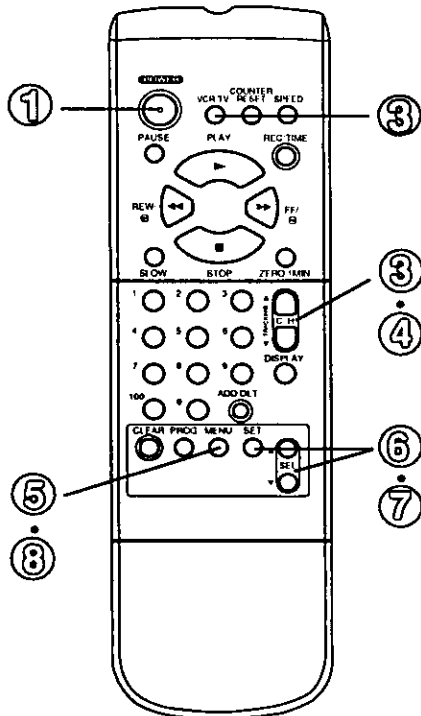
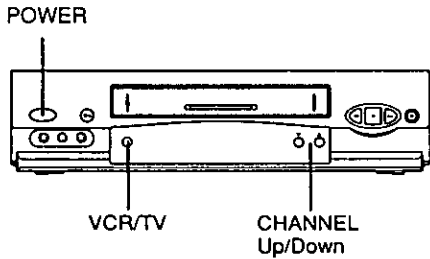

To Set Language, Channel and Clock

1



Turn TV on and VCR on.

2

TV is set to VCR channel (the Same one you set on the back of the VCR CH3 or CH4). (See page 6.)

3



Push CH ▲ for English on-screen displays.

or



Push CH ▼ for Spanish on-screen displays.

or



Push VCR/TV for French on-screen displays.

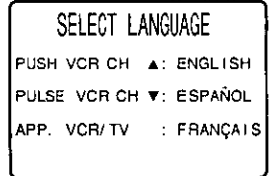

If you set the wrong language, see the "Reset all VCR Memory Functions" section on page 5.

- You can also set by using the same buttons on the VCR.

Make sure the VCR is connected to antenna or cable.

If you use a cable box, it must be left on for auto channel set.

4



Push CH ▲ to start Channel Auto Set.

- The following on-screen displays appear in sequence: "CH AUTO SET COMPLETED" "PLEASE SET CLOCK BY PUSHING MENU KEY"

5



Push MENU to display the SET CLOCK screen.

- Make entries within 5 minutes, or the VCR exits the Set Clock screen.

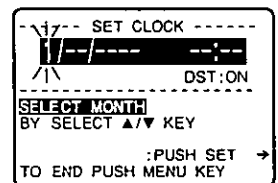

6



Push SELECT UP/DOWN to select the MONTH and push SET to enter it.

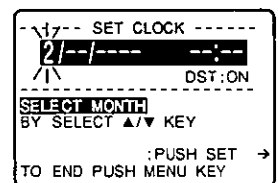

7



Push SELECT UP/DOWN and SET to set remaining items at right.

- The day of the week automatically appears.
- See page 5 for more on D.S.T.

Remaining items to be set:

- Date
- Year
- Time
- D.S.T. (Daylight Saving Time)

8



Push MENU twice to start the clock and exit this mode.

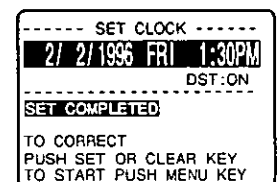

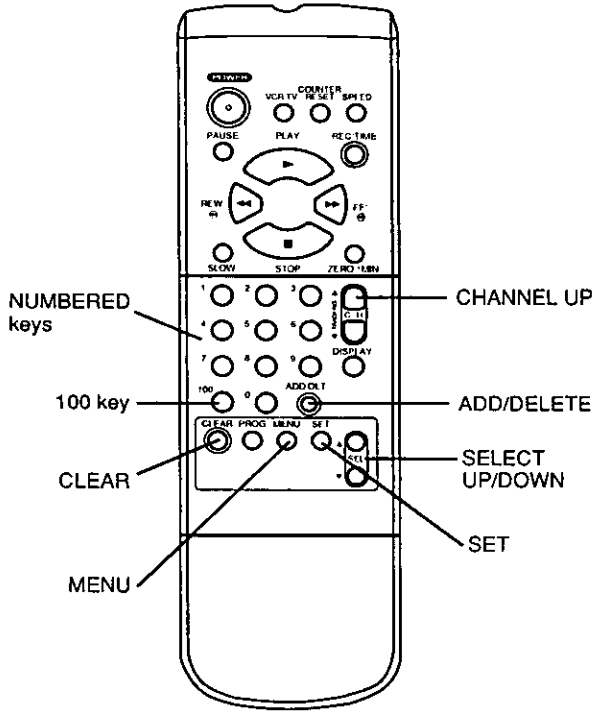

To Replace Channels in Memory

Example, if you have cable installed, etc.

- 1 Push MENU to display the menu.
- 2 Push the SELECT Up/Down and SET to select SET UP CHANNEL from menu, and then push to set your antenna system (TV or CATV).
- 3 Push the SELECT Up/Down and SET to select AUTO SET.
 - If you use a cable box, it must be left on for auto channel set.
- 4 Push CH ▲ to start Channel Auto Set.
 - To exit this mode, push MENU twice.

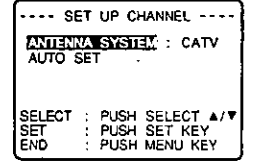
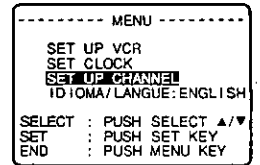

To Set or Reset the Clock

In case the clock is wrong, or a power failure occurred.

- 1 Push MENU to display the menu.
- 2 Push the SELECT Up/Down and SET to select SET CLOCK from menu, and then to set the time and date.
- 3 Push MENU twice to start the clock and exit this mode.

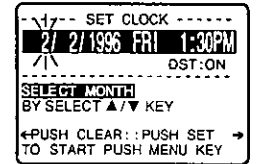
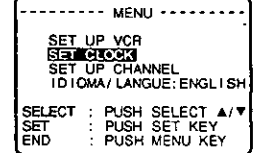

To Add or Delete a Channel

- 1 Select a channel using the NUMBERED keys.
- 2 Push ADD/HLT to add or delete the channel.

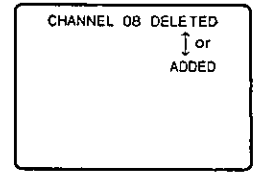

• To select a deleted channel, use the NUMBERED keys on the remote control. Deleted channels will flash in the Multi Function Display on the VCR when selected.

When Using the 100 key

When selecting CATV channels 100 to 125 with the NUMBERED keys, first push the 100 key and then enter the remaining two digits. For example, to select channel 125: Push NUMBERED keys 100, then 2, then 5.

To Change On Screen Display Language

- 1 Push MENU to display the menu.
- 2 Push the SELECT Up/Down to select the language selection item. (English: LANGUAGE, Spanish: IDIOMA, French: LANGUE).
- 3 Push the SET button to change the language.
 - Each Push will change the language in the order shown.

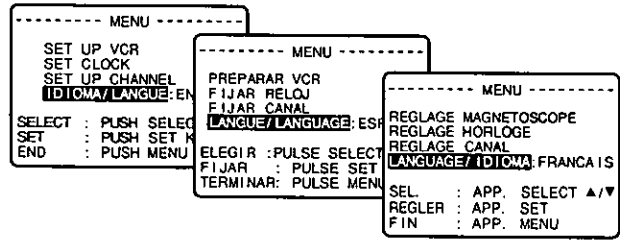
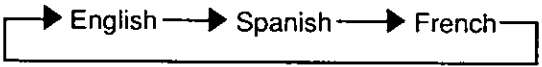
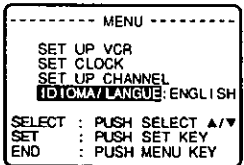

- 4 Push MENU to exit this mode.



- This VCR will accurately maintain its calendar up to Dec. 31, 2014, 11:59PM.
- Normal TV or Cable channels are automatically selected and placed in memory depending on how your VCR is hooked up.
- By pushing the SET or CLEAR button repeatedly, you can skip forward or backward over correct entries and go directly to a specific item.

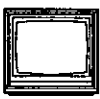

On Screen Displays (OSD)

Function & Channel Display

Whenever a function button is pushed (PLAY, FF, etc.) or the channel is changed, a 4 second OSD will appear first in large and then small characters.



Menu Screen

1 Push MENU to display the menu.

2 Push the SELECT Up/Down and SET to make your selection.

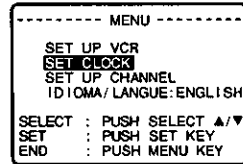

- To get the most from each feature, it is recommended that you read the Operation Manual before attempting any operation.

VCR Status & Clock Display

Push DISPLAY to display and remove the overlay shown below.

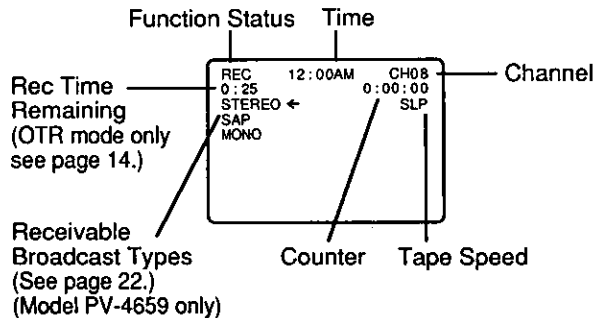

Blank Tape and will be Blue Screen

If a blank section of tape is encountered in the Play mode or the channel you select has no broadcast, the TV screen will change to a solid blue field. The screen will remain blue until a recorded signal is again detected or an active channel is selected.

Warning and Instruction Displays

These displays will alert you to a missed operation or provide further instructions.

If no active channels are found for CHANNEL MEMORY...

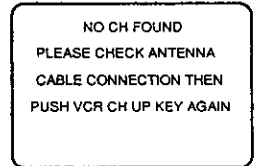

If you attempt to set or review a Timer Recording and the Clock is not set...

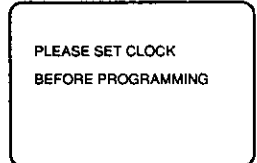

If a Timer Program was not completed before exiting the Program mode...

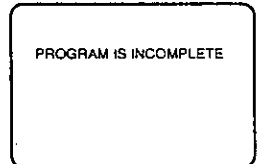

After a Timer Program has been set...

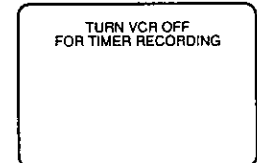

If you push REC on the remote control or REC and PLAY on the VCR, and a cassette is inserted with no record tab...

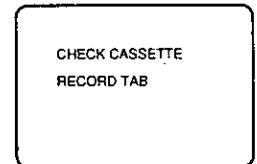

If you push PLAY, FF, REW, or REC on the remote control or if you push REC and PLAY, PLAY, FF, REW, or REC on the VCR without a cassette inserted...

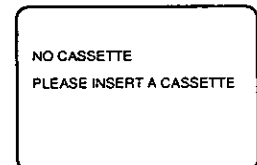

If you push POWER or STOP during a Timer Recording... (visible in VCR mode only)

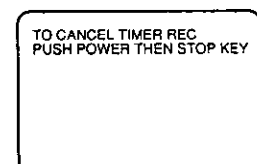

▶ Playback a Tape

☑ Check list before you begin

- All connections are made. (See pages 6~9.)
- TV and VCR are plugged in.
- TV is turned on and set to the VCR channel (CH 3 or 4).

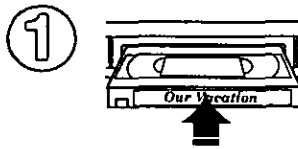
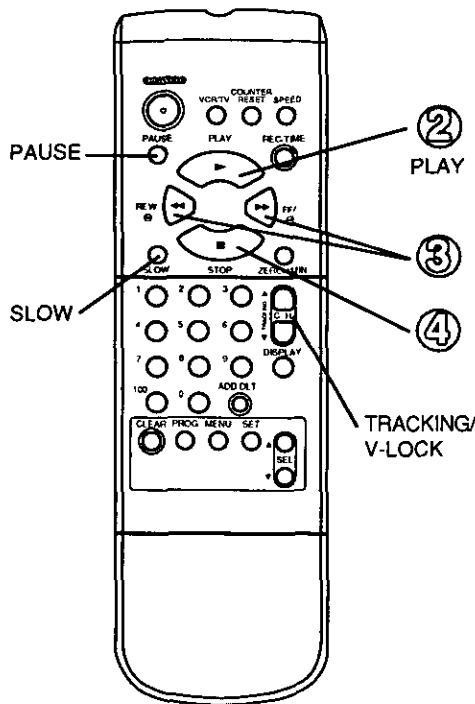
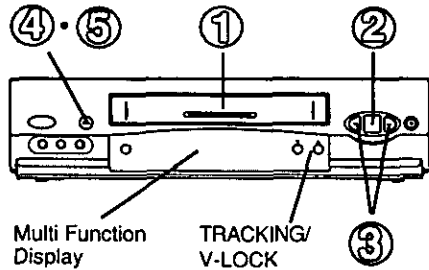

Insert a cassette.
• VCR power comes on automatically.

This indicator lights in the Multi Function Display.

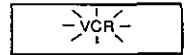

Push **PLAY** to start playback.

- Playback begins automatically if cassette has no record tab.

(VCR or Remote Control)

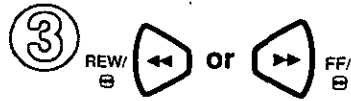

Push **REW** or **FF** to quickly locate a scene.

- SP mode tapes have a search speed of 9 times and SLP mode tapes 27 times the normal speed.
- Some noise bars will appear during search.

(VCR or Remote Control)



Push **STOP** to stop playback.

(VCR or Remote Control)



Push **STOP/EJECT** to eject the cassette.

- This button only on the VCR.

Special Effects During Playback

These features work best in SP or SLP mode. The sound will be muted. (After the VCR is in the Still or Slow mode for 3 minutes, it will go into the Stop mode automatically to protect the tape and video head.)

Slow Motion Playback

Push **SLOW** to start and **PLAY** or **SLOW** to release the Slow mode.

Still (Freeze) Frame Picture

Push **PAUSE** to freeze and release the picture.

- To reduce picture noise:

Place the VCR in Slow motion mode. Use **CH (TRACKING)** ▲/▼ to clear up the picture, then Push **PAUSE**.

Frame by Frame Advance

While in Still mode, hold down the **SLOW** button to advance the still picture one frame at a time. Push **PAUSE** to release.

Feature for a Quality picture

Digital Auto Picture

This feature automatically controls the video output signal for less noise depending on the tape condition.

Digital Auto Tracking

This feature continuously analyzes the signal and adjusts for optimum picture quality.

Manual Tracking Control

Use during Playback and Slow Motion mode to reduce picture noise. Push **CH (TRACKING)** ▲/▼ buttons until the picture clears up. To return to Auto Tracking mode, push **POWER** off and then on again.

V-Lock Control

In Still mode, the **CH (TRACKING)** ▲/▼ buttons operate as a V-Lock control to reduce jitter. Push ▲/▼ until the picture is stabilized.

Caution:

Please inspect your cassette tape for any loose or peeling labels as it may become jammed in your unit.

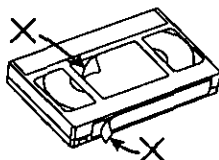

Record On a Tape

✓ Check list before you begin.

- All connections are made. (See pages 6~9.)
- VCR is Plugged in.
- TV is turned on and set to the VCR channel (CH3 or CH4).

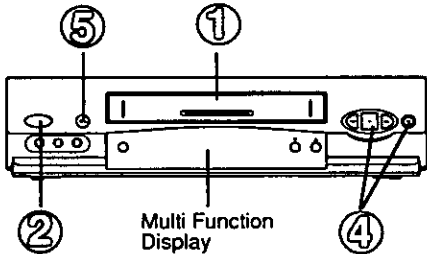

- ① Insert a cassette with record tab.
- VCR power comes on automatically.

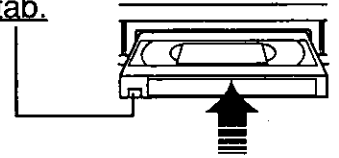

- ② Push CH ▲/▼ or NUMBERED keys to select a channel.
- Or, push CH ▲/▼ on the VCR.
 - To record from an outside source, push CH ▲/▼ to select "LINE1" or "LINE2" (see next page).

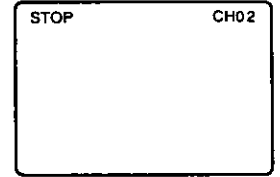

- ③ Push SPEED to change current recording speed.
- SP = Standard Play, LP = Long Play, SLP = Super Long Play.

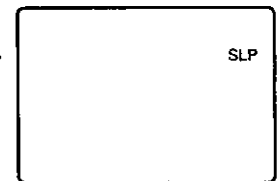

- ④ Push REC/TIME to start recording.
- Or, push PLAY and REC/TIME on the VCR.
 - Push PAUSE to pause a recording in progress. (After the VCR has been in Pause mode for 5 minutes, it will stop automatically to protect the tape and video head.)

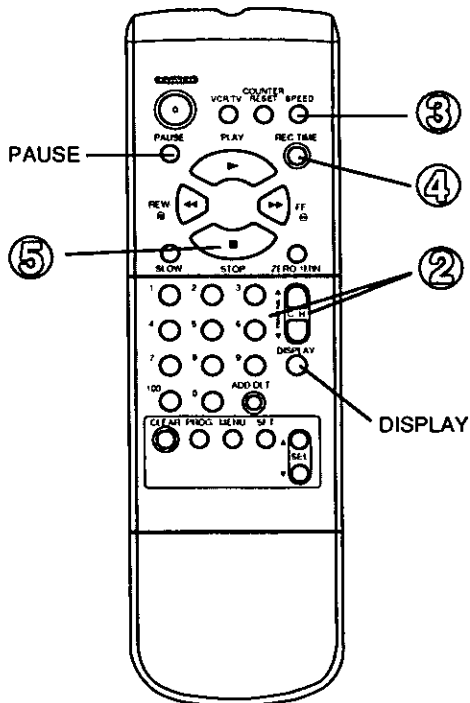

One Touch Timer Recording (OTR)

The VCR starts recording and turns itself off at a preset time.

Continue to push REC/TIME to set the recording length. Each Push will change the stop time as shown.

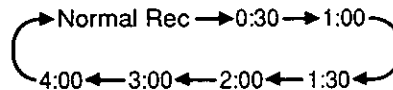

- "TIMER" lights in the Multi Function Display.
- The recording time remaining appears if the DISPLAY button is pushed during OTR mode.

- ⑤ Push STOP to stop recording.
- Or, push STOP on the VCR.



Selecting the Input Mode

- 1 Push the MENU button to display the menu.
- 2 Push the SELECT Up/Down and SET buttons to select "SET UP VCR."
- 3 Push the SELECT Up/Down to select "INPUT SELECT" and then, push to the SET button to choose TUNER or LINE (LINE1 or LINE2).

LINE1: For rear audio/video connection.
 LINE2: For front audio/video connection.

- You can also select "LINE1" or "LINE2" using the CH ▲/▼ buttons. The numbers will change in the order shown.

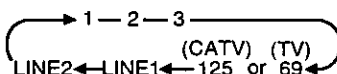

- When LINE is selected, "L1" or "L2" is displayed in the Multi Function Display.

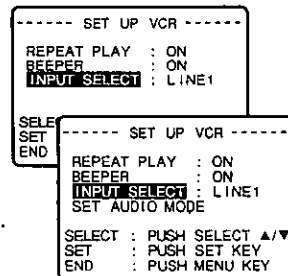
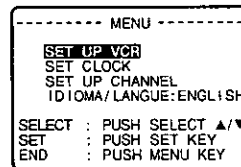

(Model PV-4659 only)

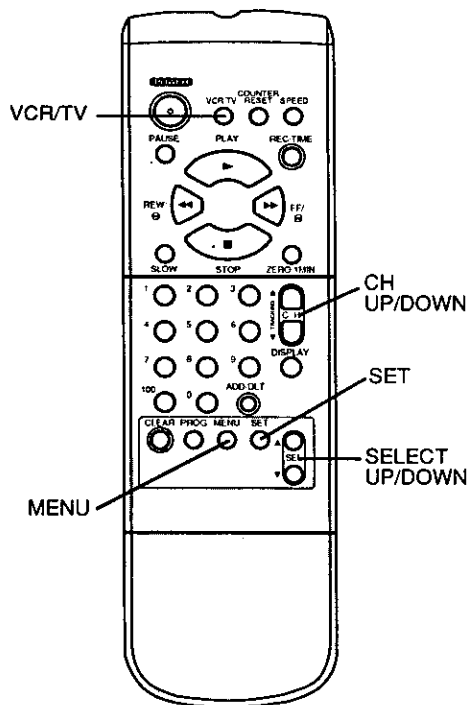
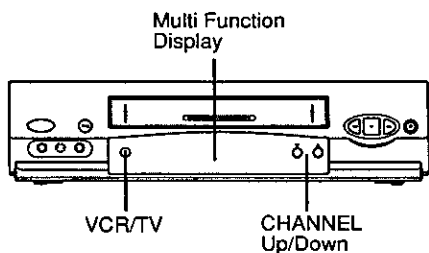

Watching Another TV Program

- 1 Push the VCR/TV button while recording is in progress to turn off the VCR indicator in the Multi Function Display.
- 2 Use the TV channel controls to select a program. The VCR will continue to record your program while you watch any channel you choose.
 - Switch back and forth between the recording and viewing channel with the VCR/TV selector.

Selecting Channels at the VCR

- 1 Turn TV on.



If indicator doesn't light, push the VCR/TV button to turn it on.

- 2 Use the CH ▲/▼ buttons to select channels for viewing or recording.
 - To resume TV control channel selection, push VCR/TV to turn VCR indicator off, or simply turn VCR off.



Tape Operation

Your VCR is equipped with several time saving features as well as convenient automatic functions which make tape operation easier than ever.

Repeat Play

You can set your VCR up to play a recording over and over.

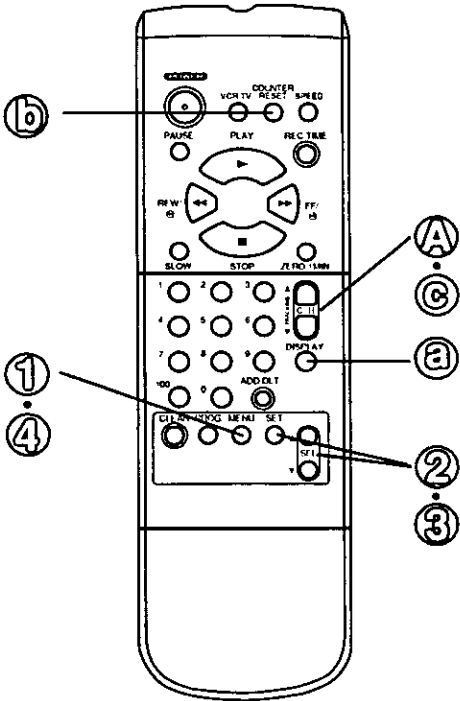

① MENU Push MENU to display the menu.

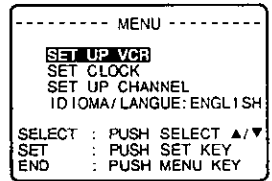

② Push SELECT UP/DOWN and SET to select SET UP VCR.

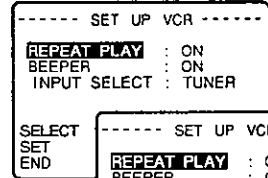

③ Push SELECT UP/DOWN to select "REPEAT PLAY", and then push SET to select "ON" or "OFF."

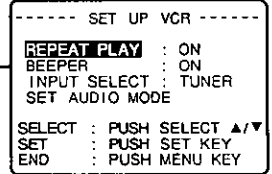

(Model PV-4659 only)

- The VCR plays to the end of a tape, or until a blank portion of 30 seconds or more is reached. (Erased portions of tape are not considered blank.) The tape is then automatically rewound and played again and again until Repeat Play is cancelled. All function buttons (REW, FF, etc.) are operational during Repeat Play.

④ MENU Push MENU twice to leave this screen.

Auto Operation Functions

Auto Playback

When a tape is inserted, the power comes on (Auto). If the record tab* is removed, playback begins (Auto).

Auto Rewind

After a tape reaches its end during playback, fast forward or manual record, the VCR will rewind and go into Stop mode.

Playback Auto Eject

After a tape without a record tab* is played to its end, the VCR will rewind and then eject the tape.

Memory Rewind Off

When the POWER button is pushed during rewind, the VCR will turn off after rewind is complete.

Eject Cassette

A cassette may be ejected with power on or off.

* For record tab information, see page 5.

One Minute Skip

With this feature, you can skip over commercials recorded on a tape.

A ZERO/1MIN Push ZERO/1MIN in Play mode.

- The VCR will go into FF search mode and skip over 60 seconds of recorded time. Then, normal playback will resume.

Zero Search

You can reset the Time Counter to zero and then return to that point.

a DISPLAY Push DISPLAY to display the Time Counter overlay.

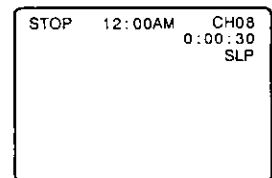

b COUNTER RESET Push COUNTER RESET to reset the Time Counter.

- This may be done at as many places as you wish on the tape.

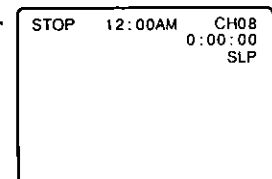

c ZERO/1MIN Push ZERO/1MIN in Stop mode.

- The VCR will go into FF or REW mode and stop at the last point the Time Counter was set to 0:00:00.



Copying Your Tapes (Dubbing)

Connections you'll need to make. (Choose front or rear connection.)

• For Model PV-4609

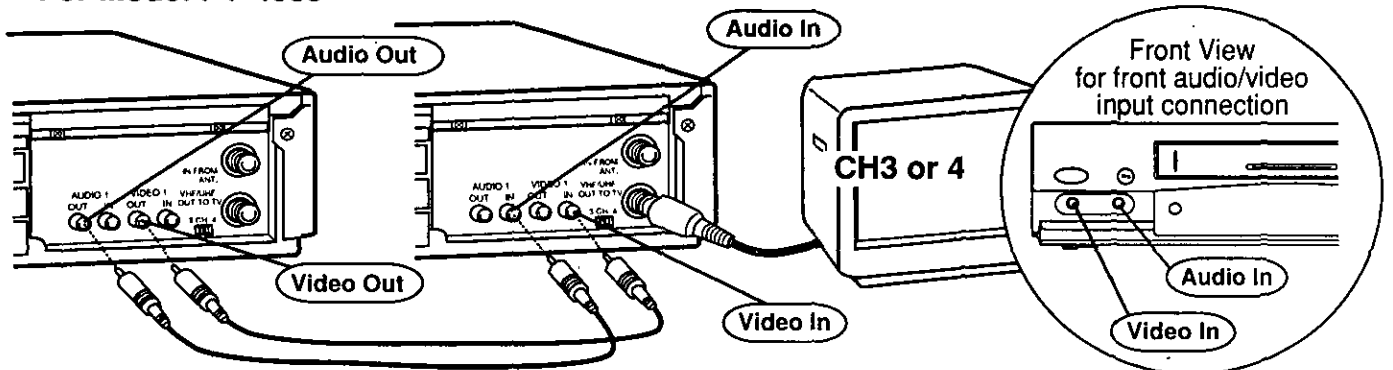

Playing (Source) VCR Recording (Editing) VCR TV for Monitoring

• For Model PV-4659

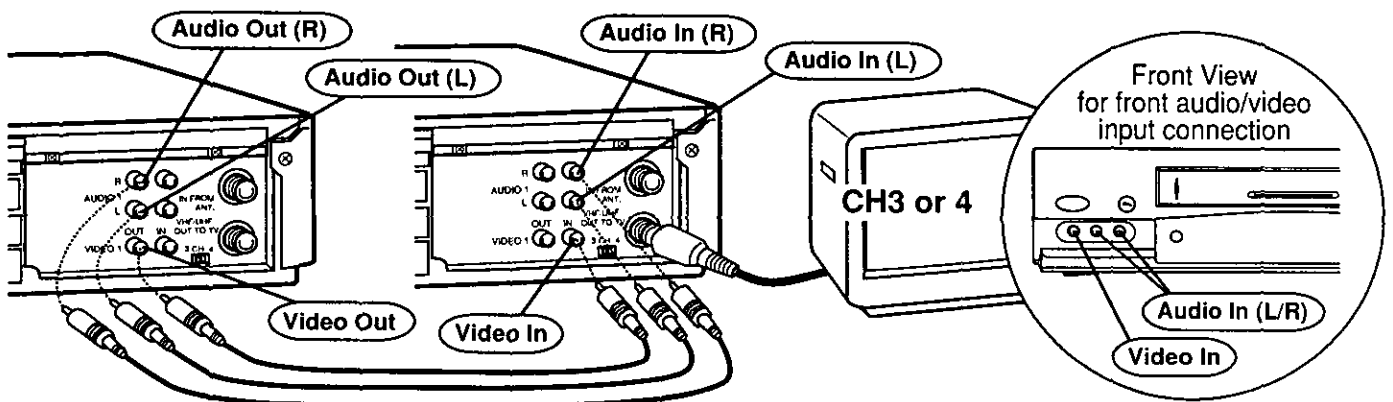

1 Insert a pre-recorded tape into the Playing (Source) VCR.

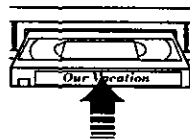

2 Insert a blank tape with record tab into the Recording (Editing) VCR.

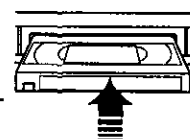

3 Select Input "LINE" on the Recording (Editing) VCR. (See "Selecting the Input Mode" on page 15.)

4 Push **PLAY** on Playing VCR. Push **PAUSE** at the point you want to start copying.

5 Push **REC** and **PLAY** at the same time on Recording VCR. Push **PAUSE** immediately.

6 Push **PAUSE** on both VCRs (at the same time), to begin copying.

Edit Out Unwanted Parts of the original recording by using the **PAUSE** button (on the Recording unit) while copying is in progress.

7 Push **STOP** on both VCRs to stop copying.

To Monitor the Re-Recording

- 1** Turn the TV on and select its VCR channel (CH3 or CH4) on the Recording VCR.
- 2** Set the VCR/TV selector on the Recording VCR to the "VCR" position.

Caution:

Unauthorized exchanging and/or copying of copyrighted recordings may be copyright infringement.

More You Can Do



Timer Recording

Your VCR can be set up to do a recording while you are away or otherwise occupied. Up to 8 programs can be placed in memory. You can choose to record one time, daily, or weekly.



Check list before you begin.

- All connections are made. (See pages 6~9.)
- TV and VCR are plugged in and turned on.
- VCR/TV selector is set to "VCR."
- Clock is set to correct time.
- Record tab in place. (See page 5.)

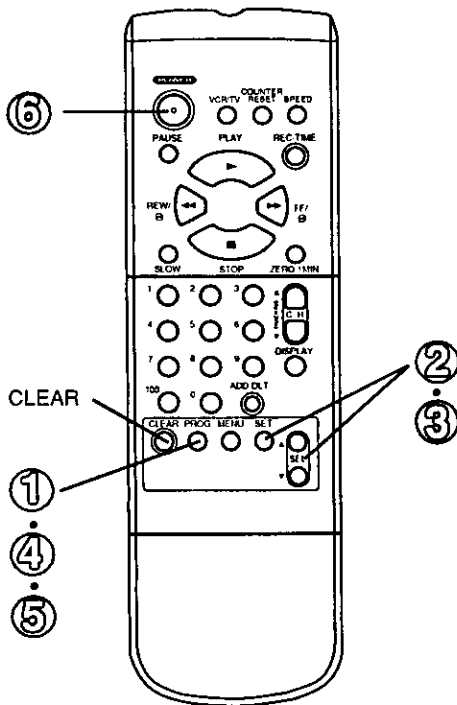
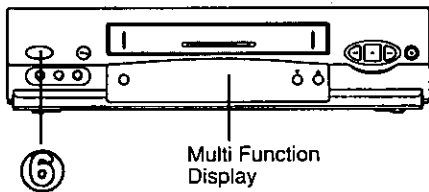

Push PROG to display the program screen.

- If a program is already in memory, push the SELECT Up/Down and SET buttons to select an unused program number.

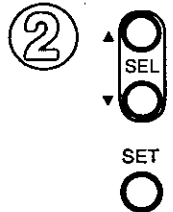
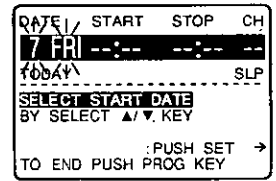

Push SELECT UP/DOWN to select the DATE, and then push to SET to enter it.

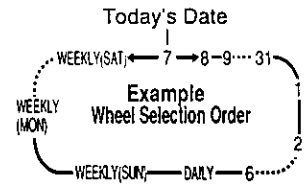

Daily and Weekly Timer Recording

If you want the program to be recorded daily (Mon thru Fri), enter DAILY in place of the DATE in step 2. If you want the recording to be on a weekly basis, enter WEEKLY MON, TUE, etc..

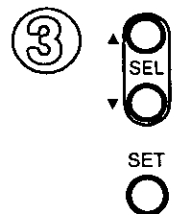
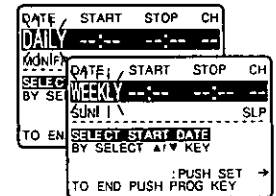

Push SELECT UP/DOWN and SET to set remaining items at right.

- Remaining Items to be set:**
- START time
 - STOP time
 - CH(annel) number, or LINE for outside source recording.
 - Speed (SP, LP, SLP).

To Make Corrections

Repeatedly push the SET button to move forward, or the CLEAR button to move back to the desired item. Then, select and set continue with step 3.

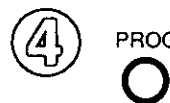

Push PROG to end the program.

- If you want to enter more programs, select a blank program number with the SELECT Up/Down and SET and repeat steps 2 and 3.

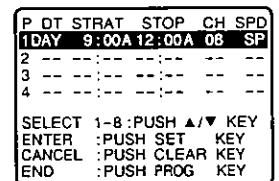

Push PROG to exit this mode.



Push POWER off to set the timer.

- When recording programs via a cable box, make sure the cable box is left ON and tuned to the desired channel.



Multi Function Display



- If the cassette record tab is missing at the time the POWER is turned OFF, the tape ejects and the TIMER indicator flashes in the Multi Function Display.
- If the start times of two programs overlap, the lower numbered program will have priority.
- If the start time for a timer recording comes up during a normal recording or One Touch Recording (page 14), the timer recording will not be performed.
- If there is a power interruption of more than one minute, the recording will not be performed or continue.
- If "PROGRAM IS INCOMPLETE" appears on-screen in step 4, check all entries and make necessary corrections.

Cancel a Timer Recording: Recording is in progress

- 1 Push the POWER button to release the VCR from timer mode.
- 2 Push the STOP button within 10 seconds of pushing the POWER button to cancel the recording. The TIMER indicator goes out in the Multi Function Display.

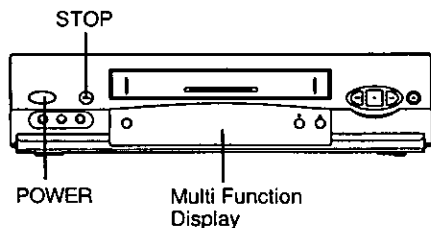

Replace Program Contents: Recording is not in progress

- 1 Push the PROG button to display all currently set programs.
- 2 Push the SELECT Up/Down and SET buttons to select and enter the desired timer recording. (See page 18.)
- 3 Push the SELECT Up/Down and SET buttons to select and enter replacement information.
- 4 Push the PROG button to exit this mode and return to the normal TV screen.

| P | DT | STRAT | STOP | CH | SPD |
|---|----|--------|--------|-----|-----|
| 1 | -- | -- | -- | -- | -- |
| 2 | 8 | 10:00P | 12:00P | 125 | SLP |
| 3 | 10 | 8:00P | 9:00P | 10 | SP |
| 4 | SU | 9:00P | 10:00P | L | SLP |

SELECT 1-8 : PUSH ▲/▼ KEY
 ENTER : PUSH SET KEY
 CANCEL : PUSH CLEAR KEY
 END : PUSH PROG KEY

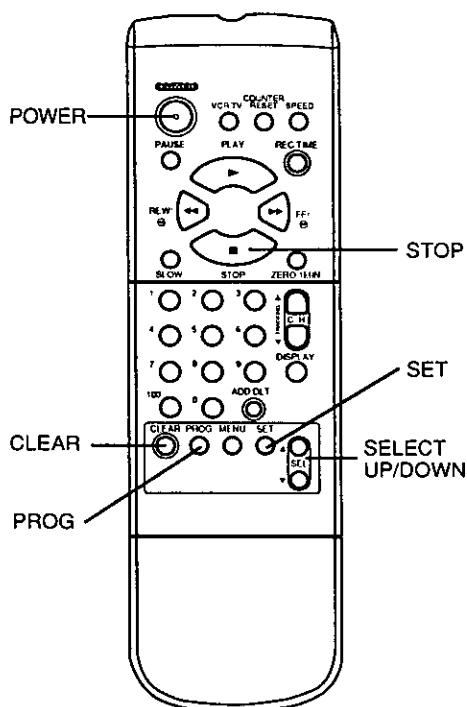

| DATE | START | STOP | CH |
|-------|--------|--------|-----|
| 8 SAT | 10:00P | 12:00P | 125 |
| 10/11 | | | SLP |

SELECT START DATE
 BY SELECT ▲/▼ KEY
 ← PUSH CLEAR : PUSH SET →
 TO END PUSH PROG KEY

Review or Clear Program Contents: Recording is not in progress

- 1 Push the PROG button to display all currently set programs.
- 2 Push the SELECT Up/Down buttons to select the desired program number.
- 3 Push the CLEAR button to clear the program.
- 4 Push the PROG button to exit this mode and return to the normal TV screen.

| P | DT | STRAT | STOP | CH | SPD |
|---|-----|--------|--------|-----|-----|
| 1 | DAY | 9:00A | 12:00A | 08 | SP |
| 2 | 8 | 10:00P | 12:00P | 125 | SLP |
| 3 | 10 | 8:00P | 9:00P | 10 | SP |
| 4 | SU | 9:00P | 10:00P | L | SLP |

SELECT 1-8 : PUSH ▲/▼ KEY
 ENTER : PUSH SET KEY
 CANCEL : PUSH CLEAR KEY
 END : PUSH PROG KEY

| P | DT | STRAT | STOP | CH | SPD |
|---|----|--------|--------|-----|-----|
| 1 | -- | -- | -- | -- | -- |
| 2 | 8 | 10:00P | 12:00P | 125 | SLP |
| 3 | 10 | 8:00P | 9:00P | 10 | SP |
| 4 | SU | 9:00P | 10:00P | L | SLP |

SELECT 1-8 : PUSH ▲/▼ KEY
 ENTER : PUSH SET KEY
 CANCEL : PUSH CLEAR KEY
 END : PUSH PROG KEY

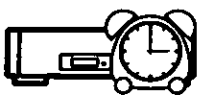

Timer Recording Using VCR Buttons

A timer recording can be set up using the buttons on the VCR. If necessary, the clock can also be set.

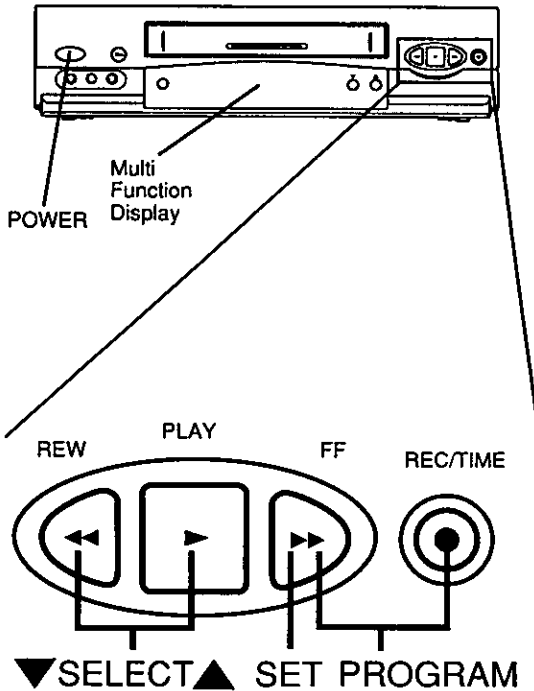

1



Hold down REC/TIME.

and



Push FF to enter the program mode.

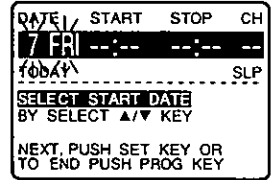

- If the clock is not set, pushing these buttons will display the SET CLOCK screen. In this case, proceed with steps 2 and 3 to set the clock and then steps 2~6 to set a timer recording.

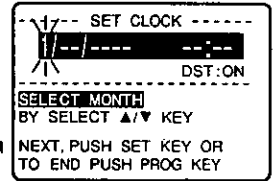

- Once the VCR is in the Program mode, the PLAY, REC, FF, and REW buttons on the VCR operate only as specified above.

2



or



Push REW or PLAY to make your selection.

(for down) (for up)

3



Push FF to set and move on to the next item.

Items to be Set:

- Push SET (FF) repeatedly to move to a particular item for setting or correction.

- recording DATE
- START time
- STOP time
- CH(annel), or LINE
- SPEED (SP, LP, SLP)

When the program is completed...

4



and



Push REC/TIME and FF to display program contents.

(at the same time)

To set the next program,

repeat steps 2, 3, and 4 before continuing with step 5.

5



and



Push REC/TIME and FF to exit this mode.

(at the same time)

6



Push POWER off to set the timer.



Multi Function Display

- It is not possible to clear a timer program using the VCR buttons. Please use the Remote Control.
- When recording programs via a cable box, make sure the cable box is left on and tuned to the desired channel.



Special VCR Features

✓ Check list before you begin.

- All connections are made. (See pages 6~9.)
- VCR is Plugged in.
- TV is turned on and set to the VCR channel (CH3 or CH4).



STOP/EJECT

VCR Lock Feature

When activated, this feature prohibits all operations except for timer recording, and tape eject. This is useful to prevent misoperation and protect your VCR from curious children.



Hold down STOP/EJECT on the VCR for 7 seconds during Stop, or Power OFF mode.

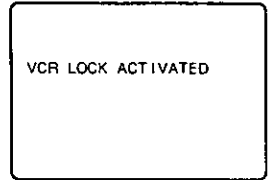

To Cancel the VCR Lock feature,



Hold down STOP/EJECT on the VCR for 7 seconds again during Stop, or Power OFF mode.

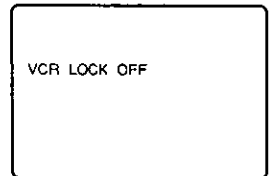

- VCR Lock mode is cancelled automatically after 24 hours when the clock is set.

Warning Beeper Feature

When you select BEEPER ON as described below, a short warning will sound each time an invalid entry or operation is made and a timer program is set.

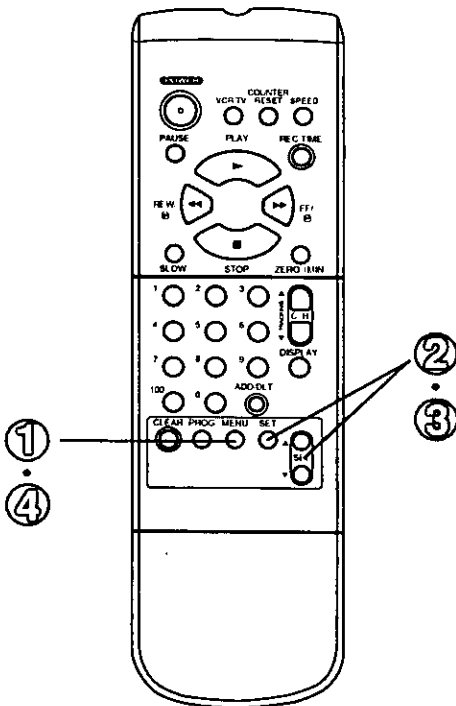

MENU

Push MENU to display the menu.

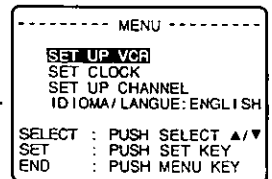

SET

Push SELECT UP/DOWN and SET to select "SET UP VCR."



SET

Push SELECT UP/DOWN to select "BEEPER", and then push SET to select "ON" or "OFF".

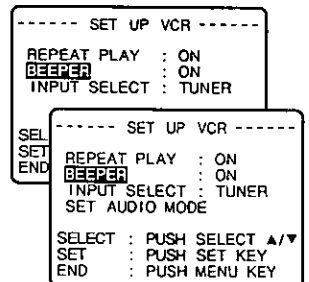

(Model PV-4659 only)



MENU

Push MENU twice to exit this screen.

More You Can Do

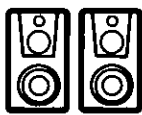

MTS Broadcast/ VHS Hi-Fi Stereo System (For Model PV-4659 only)



Check list before you begin

- The VCR is connected to a stereo TV, or a mono TV and stereo amp or receiver with speakers.
- The VCR and other components are plugged in and turned on.

Connections to Make

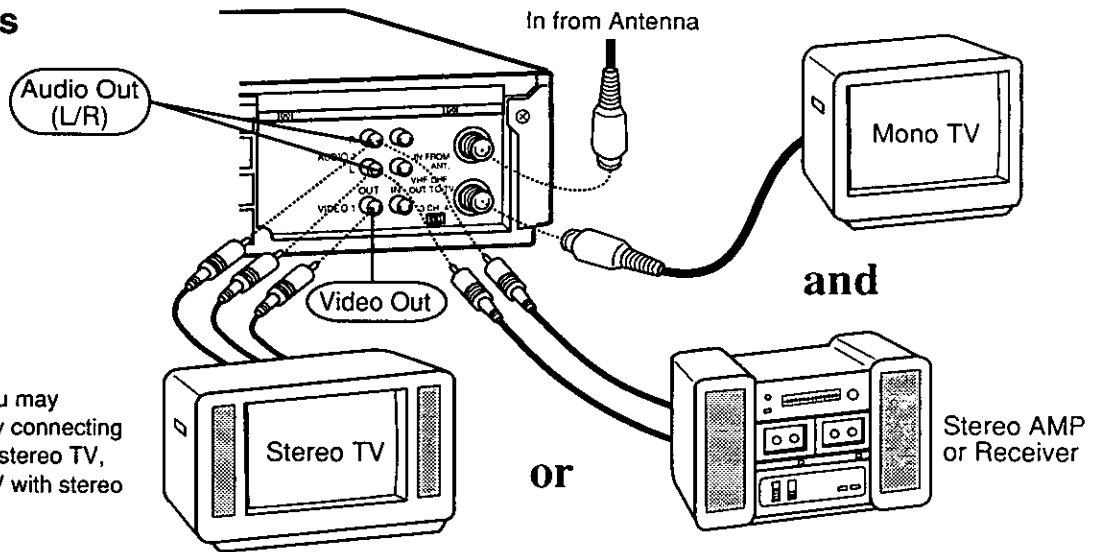

When recording, you may monitor in stereo, by connecting the VCR to either a stereo TV, or a mono sound TV with stereo amp and speakers.

Receivable Broadcast Types

The following are possible broadcast types with their accompanying on-screen displays. The signal(s) not being received is enclosed in parenthesis. The currently selected audio mode is indicated with an arrow. To change the audio mode for listening to, or recording these broadcasts, follow the steps on page 23.

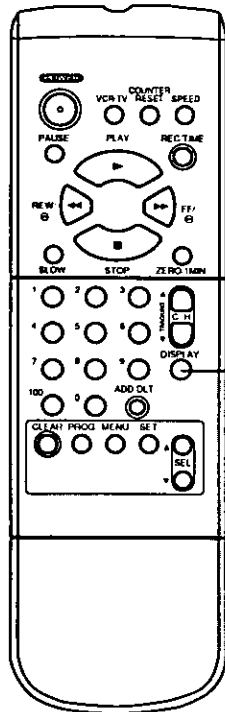

DISPLAY

DISPLAY



Push DISPLAY to display the broadcast signal currently being received on-screen.

MTS Stereo and SAP broadcast

Multi-channel Television Sound Stereo (main language) and Second Audio Program (second language) broadcasts are being received simultaneously. Select the STEREO or SAP audio mode as desired.

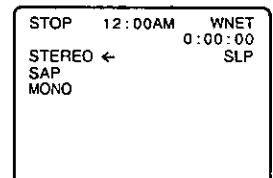

MTS Stereo broadcast

Multi-channel Television Sound Stereo broadcast is being received.

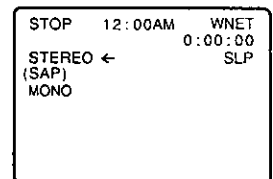

SAP broadcast

Second Audio Program (second language) broadcast is being received. Select SAP audio mode for the second language.

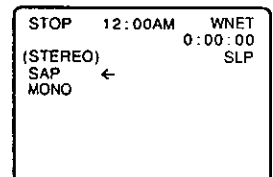

MONO broadcast

Normal monaural sound broadcast is being received.

- If a stereo broadcast is weak and the display flickers, you may want to select the MONO audio mode for better results.

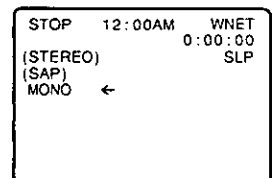

- When recording, the currently selected broadcast sound is always recorded on the left and right Hi-Fi tracks as well as the normal monaural track. This means your tapes can be played back on Hi-Fi as well as non-Hi-Fi VCRs.

Equipped with **dbx**® -TV Noise Reduction for true MTS reproduction. **dbx**® -TV Noise Reduction is required for good stereo separation and audio fidelity. **dbx**® is a registered trademark, and is licensed by **dbx**® Technology Licensing.

With the proper audio mode setting, your VCR can:

- 1) record and playback an MTS stereo broadcast (main language) in stereo Hi-Fi.
- 2) record and playback a monaural broadcast (main language) or Second Audio Program (second language) on the Hi-Fi tracks for better quality monaural sound.
- 3) playback non Hi-Fi tapes in monaural.

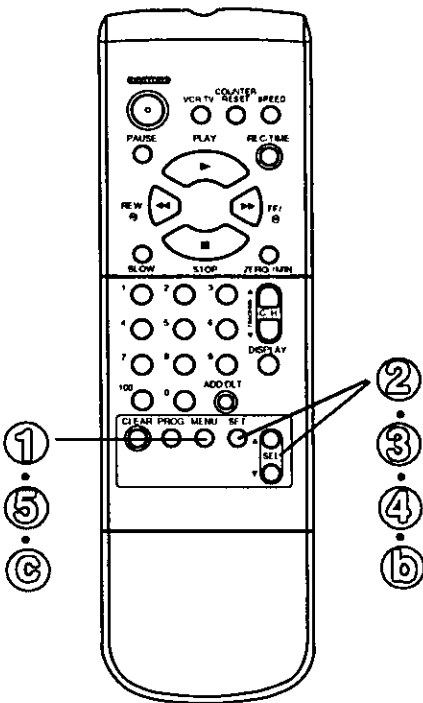

Selecting the Audio Mode for Recording

Select the type of broadcast and sound track you wish to record.



Push MENU to display the menu.

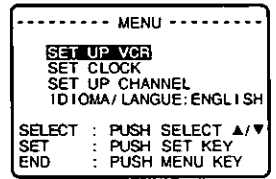

Push SELECT UP/DOWN and SET to select SET UP VCR.



Push SELECT UP/DOWN and SET to select SET AUDIO MODE.

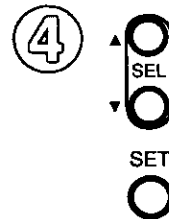
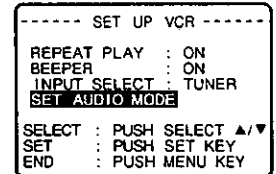

Push SELECT UP/DOWN to select AUDIO MODE, and then push SET to select the desired audio mode (STEREO/SAP/MONO).

• Please refer to "Receivable Broadcast Types" section on previous page.

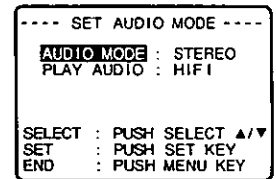

Push MENU three times to exit this mode.



Do a recording. See the "Record On a Tape" section on page 14.

Selecting the Audio Mode for Playback

Select the type of sound track you desire for playback.



Do steps 1, 2, and 3 above.

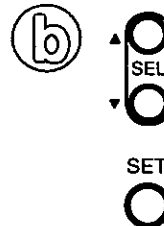

Push SELECT UP/DOWN to select PLAY AUDIO, and then push SET to select the desired audio mode (HIFI/NORMAL).

• Please select HIFI to listen to your stereo recordings with stereo sound or MONO for monaural sound.

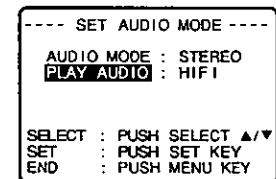

Push MENU three times to exit this mode.



Playback the tape. See the "Playback a Tape" section on page 13.



• When purchasing or renting prerecorded tapes, remember that only those recorded in Hi-Fi stereo will play back with true stereo sound. Standard stereo tapes will play back with monaural sound.

- In order to listen to Hi-Fi stereo playback, the VCR AUDIO (L/R) jacks must be connected to a stereo TV or stereo amp and speakers. (See previous page.)
- When adjusting the tracking during playback, the Hi-Fi audio sound may revert to normal audio sound. This is normal.
- There may be a difference in audio level between Hi-Fi and normal audio playback.
- If you select "HIFI", the Hi-Fi indicator lights in the Display Panel.







Before Requesting Service

Check the following points once again if you are having some trouble with your VCR.

| Power | Correction |
|---|---|
| No power... | <ul style="list-style-type: none">• Check that the Power Plug is completely inserted to an AC outlet.• Check that the POWER button is set to on. |
| Recording & Playback | Correction |
| TV program can't be recorded... | <ul style="list-style-type: none">• Check the connections between the VCR, the external antenna, and your TV.• Check that the band selected matches your antenna or cable TV system. (P.11)• Make sure that the record tab on the back of the cassette is still intact. (P.5) |
| Timer recording can't be performed... | <ul style="list-style-type: none">• Set the recording start/stop times correctly. (P.18)• Make sure that the POWER button is set to off. (P.18)• Timer recording may not be performed or continued if a power interruption of more than 1 minute occurs before, or during, Timer Recording, even if power resumes thereafter. |
| There is no playback picture, or the playback picture is noisy or contains streaks.. | <ul style="list-style-type: none">• Select the same channel on your TV as that of the Channel 3/4 switch located on the rear panel of the VCR. (P.6)• Set the VCR/TV selector to "VCR". (P.13)• Check that channel 3 or 4 of the TV is properly adjusted.• Adjust the TRACKING control slowly in either direction. (P.13) |
| During special effects playback, the picture may contain some vertical jitter when using a TV which has an Automatic Vertical Hold Control... | <ul style="list-style-type: none">• Set the TV's Vertical Hold Control to "MANUAL" and then adjust it. |
| If the top of your playback picture waves back and forth excessively... | <ul style="list-style-type: none">• Because the VCR playback signal is not as stable as an off-the-air TV signal, the top of your TV screen may be bent or unstable during playback. To solve this problem, slowly turn the horizontal hold control on your TV to correct the wavy picture. If your TV does not have a horizontal hold control or adjusting the control does not help, please contact your local TV service center. |
| VCR can't be controlled... | <ul style="list-style-type: none">• Make sure that VCR LOCK is set to off. (P. 21) |
| Remote Control | Correction |
| VCR can't be remote controlled.... | <ul style="list-style-type: none">• Aim the Remote Control directly at the remote sensor on the VCR. (Refer to Back Cover.)• Avoid all obstacles which may interfere with the signal path.• Inspect or replace the batteries (P.4).• Make sure that VCR LOCK is set to off. (P. 21)• Exposing the VCR remote sensor to direct fluorescent or outdoor light may cause signal interference. |
| Miscellaneous | Correction |
| You can't view programs normally on TV... | <ul style="list-style-type: none">• Set the VCR/TV selector to "TV". (P.15) |
| Video cassette can't be inserted... | <ul style="list-style-type: none">• Insert the cassette with the window side up and the record tab facing you. |
| Video cassette can't be removed... | <ul style="list-style-type: none">• Check that the power plug is completely connected to an AC outlet. |
| Video cassette ejects when the REC and PLAY buttons are pushed or when the POWER button is pushed off to set the Timer... | <ul style="list-style-type: none">• Make sure the record tab on the back of the cassette is still intact. (P.5) |
| In the stop mode, the motor (CYLINDER) continues to rotate... | <ul style="list-style-type: none">• To enable the quick play mechanism, the cylinder will rotate for about 5 minutes.• The quick play mechanism reduces response time from stop to PLAY mode from PLAY to REWIND search mode. |
| VCR can't be controlled... | <ul style="list-style-type: none">• Make sure that VCR LOCK is set to off. (P. 21) |

Spanish Quick Use Guide/Guía para rápida consulta

Para fijar el idioma, canal y reloj

-  Encienda el televisor y la videograbadora.
- El televisor debe estar fijado al mismo canal que ha seleccionado en la parte trasera de la videograbadora (canal 3 o 4).
-  Oprimir CH ▲ para elegir el idioma de la pantalla en inglés.
  Oprimir CH ▼ para elegir el idioma de la pantalla en español.
  Oprimir VCR/TV para elegir el idioma de la pantalla en francés.

SELECT LANGUAGE
 PUSH VCR CH ▲: ENGLISH
 PULSE VCR CH ▼: ESPAÑOL
 APP. VCR/TV : FRANÇAIS

 - Ud. podrá fijar también usando los mismos botones que están ubicados en la videograbadora.
- Esta pantalla aparecerá en unos segundos. →

 Oprimir CH ▲ para **iniciar la fijación automática de los canales.**

AUTOPROGRAMAR CANAL
 CONECTE EL CABLE DE LA ANTENA Y SI ESTÁ USANDO UNA CAJA DE TV POR CABLE SINTONICE AL CANAL PBS DE SU LOCALK LUEGO...
 POR FAVOR OPRIMIR CH UP

 - Las siguientes informaciones aparecerán seguidamente:
 "AUTOPROGRAMACION COMPLETO"
 "POR FAVOR FIJE RELOJ CON LA TECLA MENU"
-  Oprimir MENU para que aparezca la pantalla de fijación del reloj.

----- FUJAR RELOJ -----
 2 / 2 / 1996 VIE 1:30PM
 VERANO : ACT
 ELEGIR MES
 CON EL BOTÓN SELECT▲/▼
 : PULSE SET→
 PARA TERMINAR PULSE MENU

 - Introduzca los datos en 5 minutos o la videograbadora saldrá de la pantalla de la fijación del reloj.
-  Oprimir SELECT UP/DOWN y SET para fijar el mes.

----- FUJAR RELOJ -----
 2 / 2 / 1996 VIE 1:30PM
 VERANO : ACT
 ELEGIR MES
 CON EL BOTÓN SELECT▲/▼
 : PULSE SET→
 PARA TERMINAR PULSE MENU
-  Oprimir SELECT UP/DOWN y SET para fijar las fijaciones que están a la derecha.

Fijaciones:
 • Fecha
 • Año
 • Hora
 • D.S.T. (Hora veraniega)

 - El día de la semana aparece automáticamente.
-  Oprimir MENU dos veces para **iniciar a funcionar el reloj** y salir desde este modo.

----- FUJAR RELOJ -----
 2 / 2 / 1996 VIE 1:30PM
 VERANO : ACT
 FIJACION ES COMPLETO
 PARA CAMBIAR
 PULSE SET O CLEAR
 PARA INICIAR PULSE MENU

Fijación o cambio de la hora

En caso de que el reloj está incorrecto o ha ocurrido un corte eléctrico.

- Oprimir MENU para que aparezca la pantalla del menú.
- Oprimir SELECT Up/Down y SET para elegir la pantalla de la fijación del reloj y luego fijar la hora y la fecha.
- Oprimir MENU dos veces para **iniciar a funcionar el reloj** y salir desde este modo.

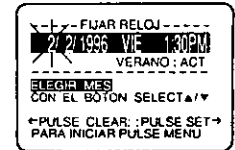

Operaciones básicas para la reproducción

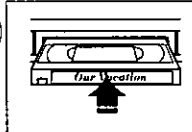
-  Introducir una cinta
 - La videograbadora se enciende automáticamente.

Esta indicación aparece en la pantalla multifuncional.
-  Oprimir PLAY para comenzar a reproducir.
 - Si la cinta no tiene la lengüeta para evitar borrado la videograbadora comienza a reproducir automáticamente.

(Videograbadora o Control Remoto)
-  Oprimir REW o FF para localizar rápidamente una escena.

(Videograbadora o Control Remoto)

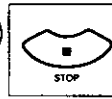
 - La velocidad de búsqueda en el modo SP es a 9 veces más rápida que la velocidad normal y en el modo SLP es a 27 veces más rápida.
 - Durante la búsqueda aparece alguna barras de ruido.
-  Oprimir STOP para parar la reproducción.

(Videograbadora o Control Remoto)
-  Oprimir STOP/EJECT para expulsar la cinta.
 - Este botón se encuentra solamente en la videograbadora.

Operaciones básicas para la grabación

1 Introducir una cinta con la lengüeta.

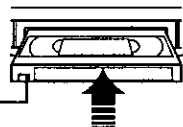

- La videograbadora se enciende automáticamente.

2 Oprimir CH ▲/▼ para elegir el canal.

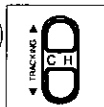

Oprimir CH ▲/▼ para elegir el canal.

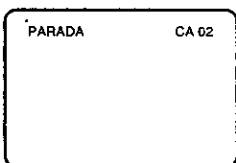

- U oprimir CH ▲/▼ en la videograbadora.
- Para grabar desde una fuente externa, oprimir CH ▲/▼ para elegir "LINEA1" o "LINEA2".

3 Oprimir SPEED para cambiar la velocidad de la cinta.

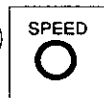

Oprimir SPEED para cambiar la velocidad de la cinta.

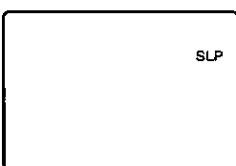

- SP = Reproducción estándar,
- LP = Larga duración,
- SLP = Superlarga duración.

4 Oprimir REC/TIME con el control remoto para empezar a grabar.



Oprimir REC/TIME con el control remoto para empezar a grabar.

- U oprimir PLAY y REC/TIME en la videograbadora.

Grabación de un toque (OTR)

La videograbadora termina la grabación a una hora programada.

Oprima sucesivamente REC/TIME para fijar el tiempo de la grabación.

Cada presión cambiará la hora de parada como demuestra al siguiente.

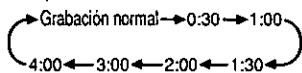

- El indicador VCR está encendido en el panel delantero.

5 Oprimir STOP para parar la grabación.

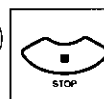

Oprimir STOP para parar la grabación.

- U oprimir STOP en la videograbadora.

- Si mantiene oprimiendo el botón de CH ▲/▼ aumentará la velocidad del cambio del canal.
- Oprimir PAUSE para hacer una pausa en la grabación en progreso.

Programación fácil para la grabación con temporizador

1 Oprimir PROG para que aparezca la pantalla de la programación.



Oprimir PROG para que aparezca la pantalla de la programación.

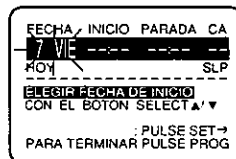

- Si ya existe una programación, elija usando la rueda un número sin programación.

2 Oprimir SELECT UP/DOWN y SET para elegir y fijar la fecha.

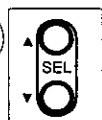

Oprimir SELECT UP/DOWN y SET para elegir y fijar la fecha.

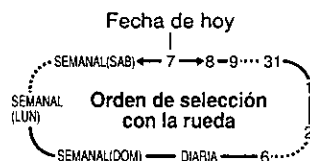

Grabación diaria y semanal

Si ud. desea programar una grabación diaria (lunes a viernes), elija DIARIO en vez de la fecha en el paso 2. Si desea una grabación semanal, elija SEMANAL LUN, MAR, etc.



3 Oprimir SELECT UP/DOWN y SET para elegir y fijar las fijaciones a la que sobran.

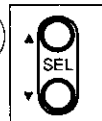

Oprimir SELECT UP/DOWN y SET para elegir y fijar las fijaciones a la que sobran.

Fijaciones:

- Hora de inicio
- Hora de parada
- Canal o LINEA para una fuente externa
- Velocidad de la cinta (SP, LP, SLP).

Para hacer correcciones

Oprimir SET sucesivamente para avanzar u oprimir CLEAR para retroceder hasta el paso que desea corregir.

4 Oprimir PROG para terminar la programación.



Oprimir PROG para terminar la programación.

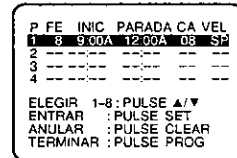

- Si desea hacer más programaciones, elija un número de programa en blanco con SELECT Up/Down y SET, y luego repita los paso 2 y 3.

5 Oprimir PROG para salir desde este modo.

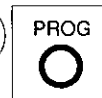

Oprimir PROG para salir desde este modo.

6 Oprimir POWER para la grabación con temporizador.

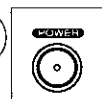

Oprimir POWER para la grabación con temporizador.



Pantalla multifuncional

- Si la fuente de la grabación es una caja de TV por cable, asegúrese de que la caja de TV por cable esté encendido y esté sintonizado al canal que desea grabar.

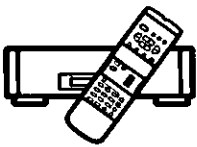

Index of Controls

Multi Function Display

VCR Indicator

Appears when the VCR/TV selector is set to VCR.

Hi-Fi Indicator

When Hi-Fi audio is monitored or played back, this indicator appears. (PV-4659 only)

Power Indicator

This indicator lights when power is turned on.

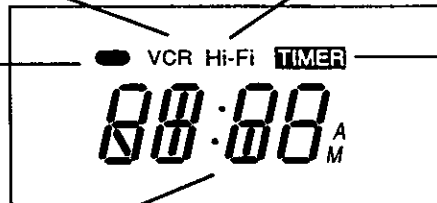

Timer Indicator

This indicator lights when the VCR is set for a Timer Recording, or if a length is set for normal recording. It flashes when a Timer Recording has been set, but a tape has not been inserted into the VCR.

Clock/Status/Channel Display

Displays the current time.

Briefly displays VCR status when function button is pressed.

Also, briefly displays the channel number selected, "L1" or "L2" when channel button is pressed or select a line input.

Rear View of the VCR

• For Model PV-4609

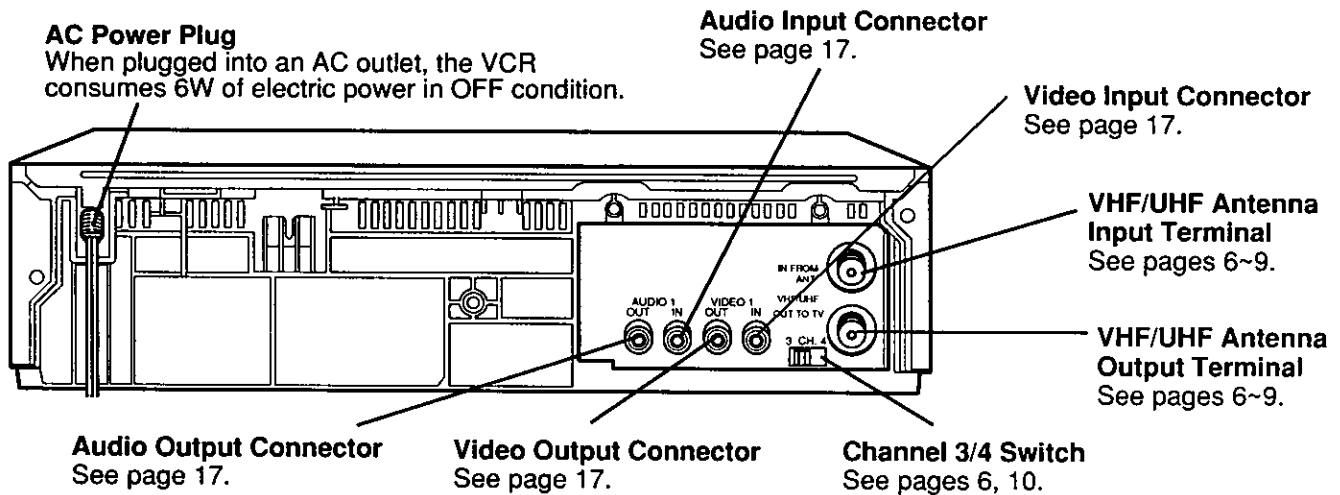

• For Model PV-4659

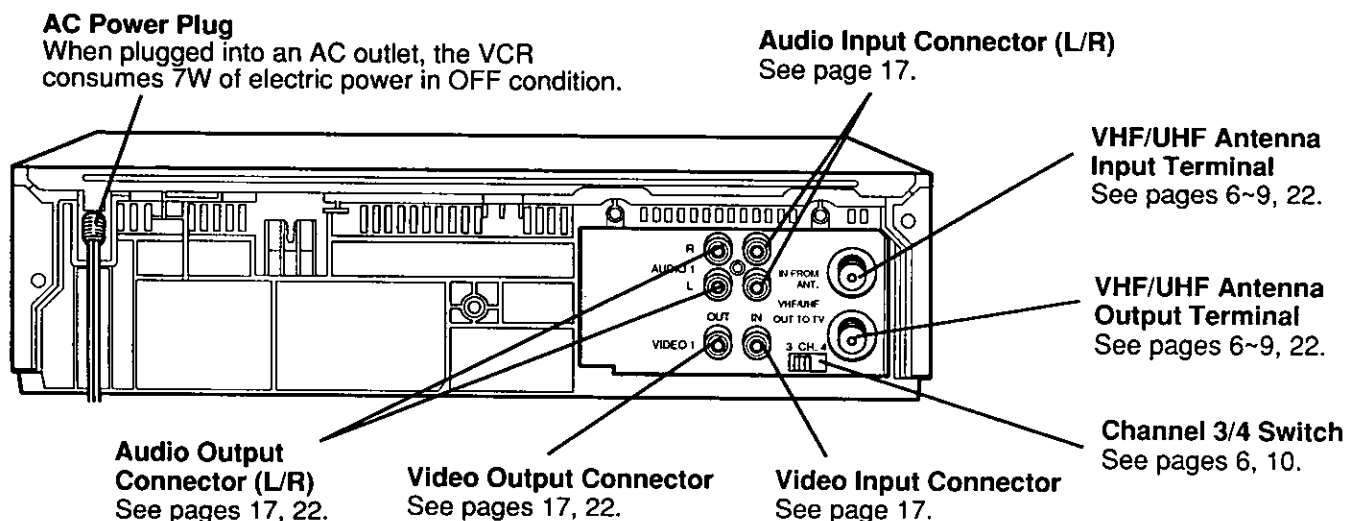

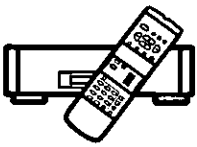

Index of Controls

Remote Control Button

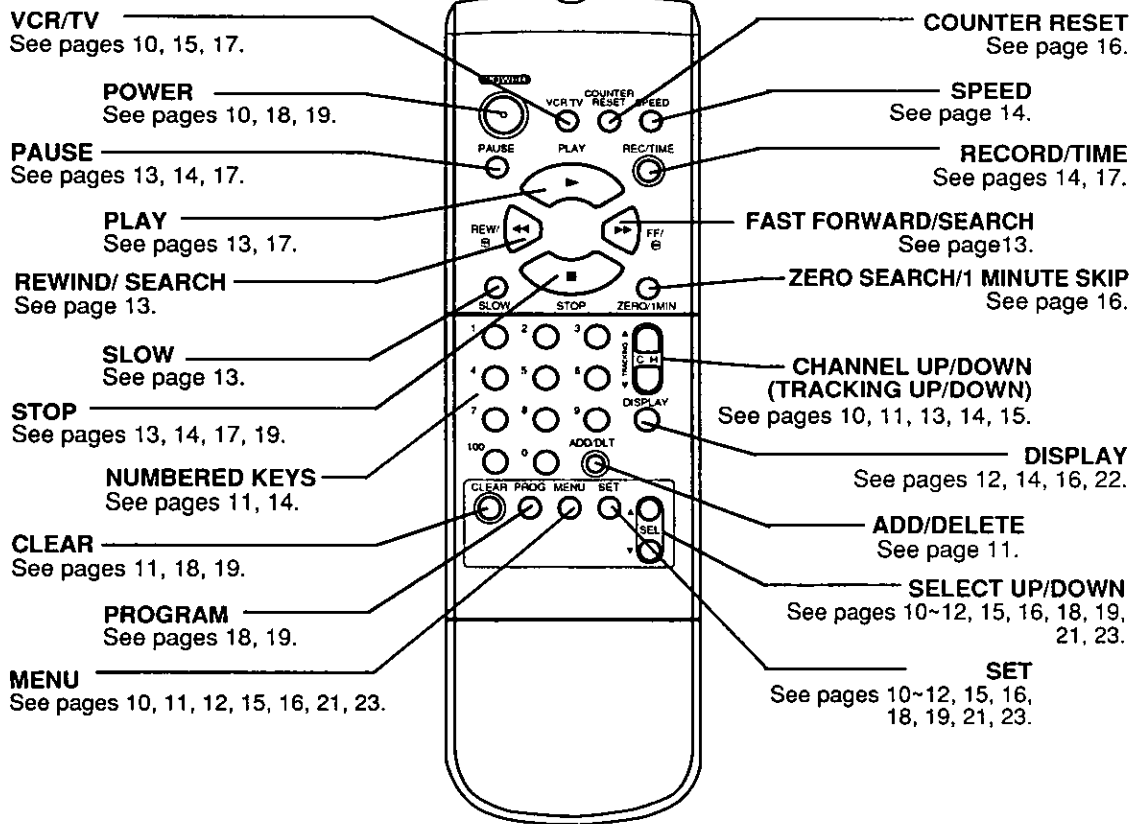

Front View of the VCR

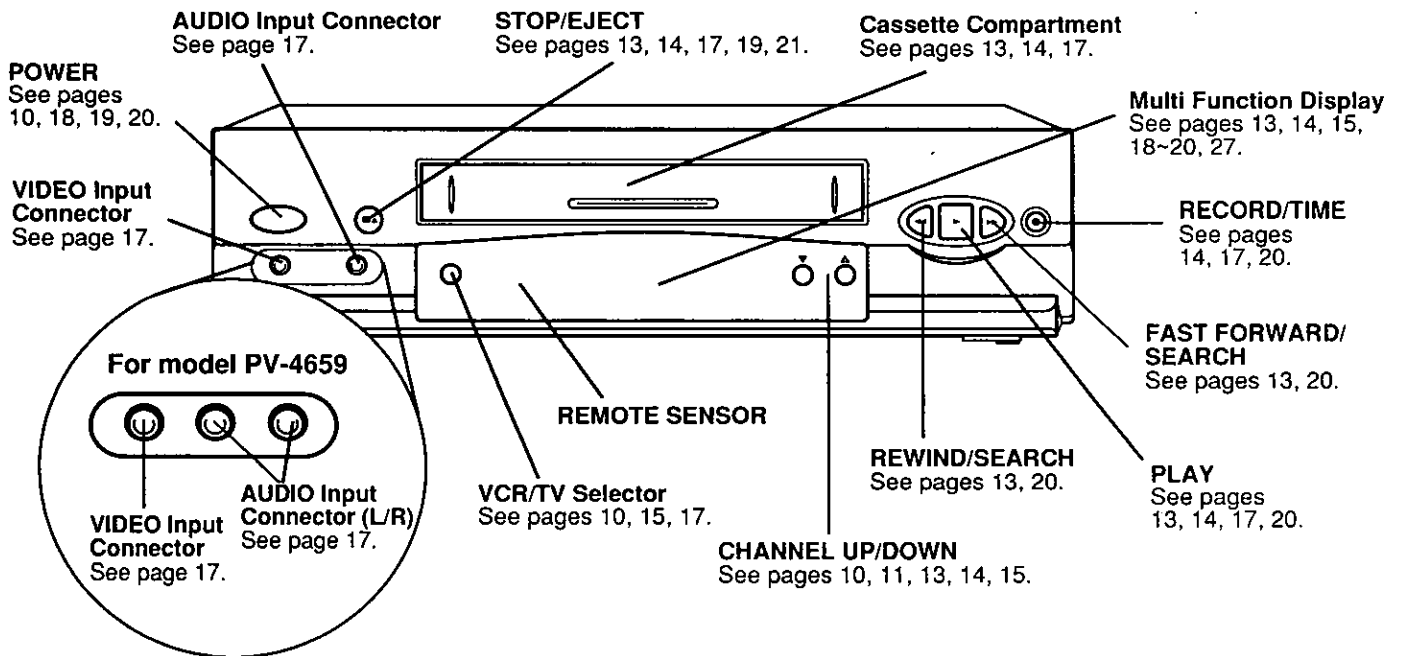

Matsushita Consumer Electronics Company, Division of Matsushita Electric Corporation of America
One Panasonic Way Secaucus, New Jersey 07094

Panasonic Sales Company, Division of Matsushita Electric of Puerto Rico, Inc. ("PSC")
Ave. 65 de Infanteria. Km. 9.5
San Gabriel Industrial Park, Carolina, Puerto Rico 00985

